

# 2023 - 2024 CATALOG



## SA-2600

Electrical Safety Analyzer



## IPA-3100

Infusion Pump Analyzer



@BCGroup1988



@BCGroupStore



@BCGroupIntl



@BCGroupIntl



@company/bc-group-international-inc



BCGroupStore.com  
1-314-638-3800

SF-SLS-181 (BD)

**BC Group was founded in 1988, and 2023 marks our 35th Anniversary!** In 2000, we began manufacturing our own product line under the now familiar green and gold “BC Biomedical” label.

In January of 2005, Lloyd Industries, the company that engineered and manufactured most of the BC Biomedical brand products, purchased BC Group. This acquisition has allowed our products and services to expand at an even faster pace. BC Group, under the “BC Biomedical” brand, is now the second largest manufacturer of biomedical test and measurement equipment in the world.



Our philosophy with BC Biomedical products runs counter to the current trend of “one-size-fits-all”. We offer families of products that provide the users with a choice of models so they can pick the features they need at a price they can afford. BC Group has a major commitment to quality at all levels of operation.

BC Group is certified to ISO 9001:2015 and ISO 13485:2016. Our service center is accredited to both ANSI Z540-1 and ISO/ IEC 17025:2017 with full traceability to NIST.

We are registered with and inspected by the FDA and follow the Good Manufacturing Practices (GMP). We comply with the QSR (Quality Systems Regulation) 21 CFR 820.



SECTION ONE



BC QUALITY DESIGN,  
ENGINEERING & MORE.....3-8

SECTION TWO



ANESTHETIC AGENT ANALYZER.....9-12  
 BLUETOOTH COMPATIBILITY.....13-14  
 DEFIBRILLATOR ANALYZERS.....15-18  
 ESU ANALYZER SERIES.....19-26  
 FLOW ANALYZER.....27-28  
 INFUSION PUMP ANALYZER.....29-38  
 LUNG SIMULATORS.....39-40  
 NIBP SIMULATOR 1000 SERIES.....41-44  
 OXYGEN ANALYZERS.....45-46  
 PATIENT SIMULATORS.....47-52  
 PRESSURE METERS.....53-58  
 PULSE OXIMETRY TESTING.....59-62  
 SAFETY ANALYZERS.....63-68  
 TACHOMETER.....69-70  
 ULTRASOUND LEAKAGE TESTER.....71-76  
 ULTRASOUND WATTMETERS.....77-78

SECTION THREE

COMPARISON CHARTS.....79-83

FEATURED VENDOR ALLIANCE PRODUCTS

**AG INSTRUMENTS** .....85-86  
Technology made to measure™

◆MGV100 MEDICAL GAS ANALYZER

**DIAGNOMATIC** by *Pro-Project* .....87-88

◆PRO-MRI ACR MEDIUM

**IMT.Analytics** .....89-92

◆PF300-PRO FLOW ANALYZER  
 ◆CITREX H5

**OHMIC INSTRUMENTS** .....93-96

◆AMM-15 DEW POINT METER  
 ◆ULTRASOUND POWER METERS

**RTI** INDEPENDENT X-RAY  
 QUALITY ASSURANCE.....97-100

◆BLACK PIRANHA SERIES  
 ◆COBIA SERIES

**TSI** Knowledge Beyond Measure. ....101-104

◆CERTIFIER PLUS

SECTION FOUR .....105-161

◆BC MARKETPLACE & PRICING

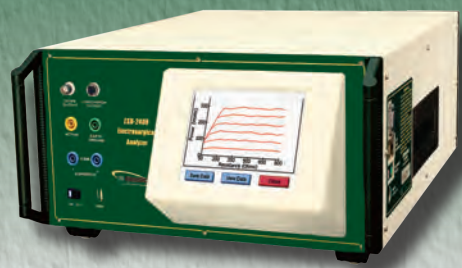

Any of the trademarks, service marks or similar rights that are mentioned, used or cited within are the property of their respective owners. Their usage here does not imply endorsement or affiliation with any of the holders of any such rights.



BC Group consists of three interlinking operations:  
**BC Biomedical, BC Marketplace** and **BC Service**.

In January 2005, Lloyd Industries, our parent organization, added engineering, design and manufacturing capability when they purchased BC Group.

Since then, our list of BC Biomedical products has grown substantially. In January 2009, BC Group moved all our departments into one new facility, allowing us to better serve our customers.

BC Group's growth has come from listening to customers and then providing what they want. BC Group is now the second largest manufacturer of biomedical test equipment in the world and growing.

We are truly **YOUR ONE-STOP BIOMED SHOP**.



BC Group distributes over 75 product lines under BC Marketplace, including our own BC Biomedical brand and other vendor alliances. Our in-house professional sales department, the printed catalog, and the online catalog found at [BCGroupStore.com](http://BCGroupStore.com) falls under the BC Marketplace umbrella.

*Why should you buy items from BC Group that can be purchased directly from the OEM?*

- (1) Price - We buy in volume. (2) We have stock. (3) It is expensive for an organization to cut a purchase order. For instance, if you need to order 5 items from 5 different vendors, you may be paying much more than if you cut one PO to BC Group for all 5 items.
- (4) You may only buy one or two items from a vendor in a year where we purchase hundreds of items from that same vendor.

If you have any problems with a manufacturer's product, you'll have BC Group as your advocate.



BC Group designs and manufactures a complete line of test equipment under the BC Biomedical label. The familiar Green and Gold overlays tell you that you are getting the latest technology available in the biomedical field today.

BC Biomedical products have been designed with the customer in mind. Most of our instruments are offered as families of products. We do not subscribe to the theory that one-size-fits-all. You choose the features you want and only pay for what you need.

The BC Biomedical product offering is extensive but we have many more in the works that will be introduced after this catalog is published.

Please check our website for the latest products being introduced or contact us about being added to our BC Group email newsletter list.



BC Group offers support for the Biomedical Industry's test equipment under the brand called BC Service. Under BC Service, we calibrate, repair, manage and store test equipment for our customers. We have a dedicated technical staff that has been specializing in biomedical test equipment repair and calibration for many years. You choose at what location your equipment is serviced.

BC Group offers test equipment calibration and repair service for all BC Biomedical and most other manufacturers of test equipment at our St. Louis Depot facility. BC Group also offers a nationwide, onsite calibration service program where our technicians arrive to your facility in order to minimize downtime and shipping costs. We offer multi-year discounts on your calibration cost, plus you will enjoy special discounting when purchasing test equipment if you use BC Group as your onsite provider.

We are ISO 9001:2015 Certified, ISO/IEC 17025:2017 Accredited, NIST Traceable and ANSI Z540-1 compliant.

# Quality

Is at the heart of everything we do at BC Group



BC Group is committed to exceeding customer expectations and enhancing customer satisfaction through the continual improvement of our products, services and quality management system.

BC Group has been ISO certified for over a decade.

## Our Quality Programs

- ISO 13485:2016 Certified*
- ISO 9001:2015 Certified*
- ISO/IEC 17025:2017 Accredited*
- ANSI Z540-1 Accredited*
- FDA Registered & Inspected*
- FDA - QSR 21 CFR 820 Compliant*
- FDA - CGMP Compliant*
- NIST Traceable*



# Engineering

Designing new products and automated test rigs

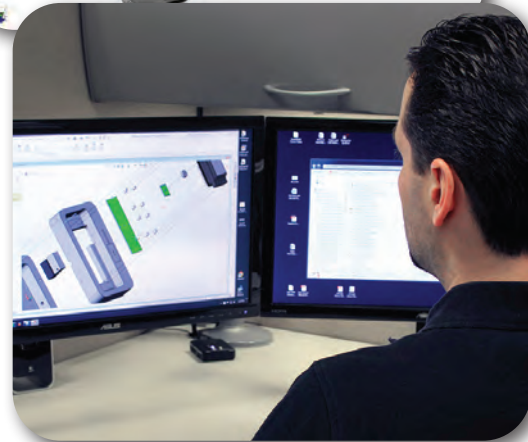
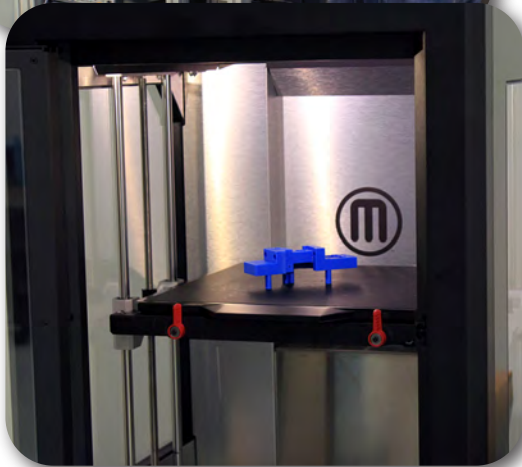

Having an in-house engineering department allows us to respond to new requirements and demands from the field. We design everything from custom enclosures to circuit boards to packaging. We also develop our own software, providing unparalleled service to our customers.

## Production

In-house manufacturing of components, assemblies and complete products. Made in the USA.



Our Production Department meets the highest standards and operates under our quality program



ANESTHETIC AGENT ANALYZERS  
DEFIBRILLATOR ANALYZERS  
DEPOT CALIBRATION  
DEPOT REPAIR  
ESU ANALYZERS

INFUSION PUMP ANALYZERS  
NIBP SIMULATORS  
ON-SITE CALIBRATION  
OXYGEN ANALYZERS  
PATIENT SIMULATORS

PULSE OXIMETRY SIMULATORS  
RADIOLOGY TEST EQUIPMENT  
SAFETY ANALYZERS  
ULTRASOUND WATTMETERS  
ULTRASOUND LEAKAGE TESTERS



# Depot

Our ISO-17025:2017 Accredited lab calibrates BC Biomedical and most other brands of test equipment

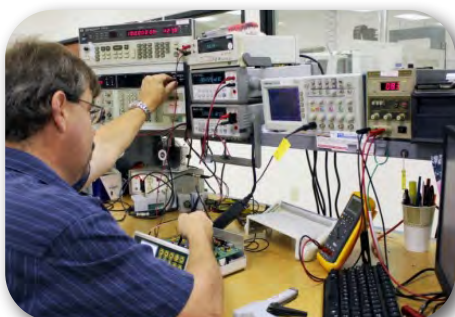
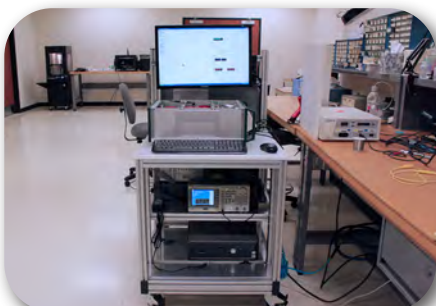

## BC Group offers Onsite Calibration Services

We bring our technicians and expertise to your facility to maximize uptime.



## PORTABLE ANESTHETIC AGENT ANALYZER



### AA-8000

The AA-8000 is the latest in manual agent selection, portable anesthetic agent analyzers. It was designed to meet the demand for a small, easy to use unit with high reliability and accuracy.

Utilizing proprietary state-of-the-art digital NDIR (Non-Dispersive Infrared) Technology it provides a cost effective, high function, microprocessor-based analyzer that is simple to operate while maintaining high performance and accuracy.

The unit's flexible design and portable size makes it the ideal service tool for anesthesia service applications in hospitals and surgical centers. It has a slanted display and adjustable handle/stand to allow for ease of viewing. The internal rechargeable lithium-ion battery provides for hours of continuous operation.

One button selection of the agent-to-be-analyzed coupled with one button control over the sampling pump, makes the unit simple and quick to use. No complex menus and key combinations are required.

The internal data logger combined with the internal clock allows for the storage of up to 500 time and date stamped downloadable readings, exported to a desktop or laptop via USB Interface.

Flash memory and the USB interface allow for field upgrades with downloads from our website.



# FEATURES & SPECIFICATIONS

- ◆ State-of-the-art NDIR (Non-Dispersive Infrared) technology
- ◆ Measures 4 anesthetic agent gases: sevoflurane, isoflurane, desflurane and halothane
- ◆ Small, portable unit with adjustable handle/stand
- ◆ Large graphical display with backlight
- ◆ User friendly interface:
  - One button agent select
  - One button sample (pump) control
- ◆ Auto compensation for temperature and barometric pressure
- ◆ Built-in sampling pump
- ◆ Gas flow sampling at 200 mL/min
- ◆ Manual, automatic and remote operation
- ◆ Internal data logging with date, time and DUT Tag - 500 samples
- ◆ Rechargeable battery
- ◆ USB computer interface
- ◆ Field upgradeable - flash memory
- ◆ Fast warmup time
- ◆ Comes with NIST Traceable calibration certificate with data
- ◆ Service tool for anesthesia service application (NOT FOR CLINICAL USE)
- ◆ Made in USA

GENERAL		
Model	AA-8000 Series Anesthetic Agent Analyzer	
Measurement Technology	NDIR (Non-Dispersive Infrared)	
Gases	Sevoflurane, Isoflurane, Desflurane, Halothane	
Accuracy	+/- (0.05% Vol% + 4% relative)	
Range (Iso, Sevo and Halo)	0 to 8.00%	
Range (Des)	0 to 20.00%	
Resolution	0.01%	
Detection Minimum	0.15%	
Sampling Method	Suction Pump (internal)	
Sampling Rate	200 mL/min	
Internal Memory	Flash	
Interface	USB Device	
ELECTRICAL		
AC POWER	90 to 275 VAC, 50/60 Hz	
AC POWER ADAPTER	12 VDC, 1.5 A  BC20-21115 (Universal)	
BATTERY	Internal Rechargeable Li-Ion battery pack	
BATTERY RUNTIME	12 Hours Continuous	
PHYSICAL & ENVIRONMENTAL		
DISPLAY	128 X 64 Pixels Graphical LCD, White LED Backlight	
SIZE	7.9 x 6.8 x 3.0 Inches (200 x 173 x 76 mm)	
WEIGHT	< 3.5 Lbs. (1.6 kg)	
CONSTRUCTION	ENCLOSURE	ABS Plastic
	OVERLAY	Back-Printed Lexan
OPERATING RANGE	15 to 40 °C (59 to 104 °F)	
OPERATING ALTITUDE	Up to 10,000 ft	
OPERATING PRESSURE	660 -1200 mBar	
STORAGE RANGE	-20 to 60 °C (-4 to 140 °F)	

# PORTABLE ANESTHETIC AGENT ANALYZER WITH BLUETOOTH® WIRELESS TECHNOLOGY

## Anesthetic Agent Analyzer



Compatible with  
**myBC mobile**



## AA-8100

The AA-8100 is an enhanced version of the AA-8000, adding auto agent ID, Bluetooth, iOS and Android Apps, CO<sub>2</sub> gas analysis and 100 DUT Tags - downloadable from a PC, tablet or smartphone.

It was designed to meet the demand for a more advanced, small, easy to use unit with high reliability and accuracy. Utilizing proprietary state-of-the-art digital NDIR (Non-Dispersive Infrared) technology, it provides a cost effective, high function, microprocessor-based analyzer that is simple to operate while maintaining high performance and accuracy.

The unit's flexible design, portable size and Bluetooth smart device interface make it the ideal service tool for anesthesia service applications in hospitals and surgical centers. It has a slanted display and adjustable handle/stand to allow for ease of viewing. The internal rechargeable lithium-ion battery provides hours of continuous operation.

Auto agent ID or manual one button selection of the agent-to-be-analyzed coupled with one button control over the sampling pump, makes the unit simple and quick to use. No complex menus and key combinations are required.

The internal data logger combined with the internal clock allows for the storage of up to 1000 time and date stamped readings. These downloadable reports and remote operation can be done through either USB or Bluetooth® connectivity.



## FEATURES & SPECIFICATIONS

- ◆ Auto Agent ID
- ◆ With **Bluetooth**® wireless technology
- ◆ iOS and Android Apps myBC Mobile
- ◆ 100 downloadable DUT Tag Fields
- ◆ State-of-the-art NDIR  
(Non-Dispersive Infrared) technology
- ◆ Measures 4 anesthetic agent gases:  
sevoflurane, isoflurane, desflurane,  
halothane
- ◆ Measures CO<sub>2</sub>
- ◆ Small, portable unit with adjustable  
handle/stand
- ◆ Large graphical display with backlight
- ◆ User-friendly interface:  
One button or auto agent select  
One button sample (pump) control
- ◆ Auto compensation for temperature  
and barometric pressure
- ◆ Built-in sampling pump
- ◆ Gas flow sampling at 200 mL/min
- ◆ Manual, automatic & remote operation
- ◆ Internal data logging with date, time  
and DUT Tag - 1000 samples
- ◆ Rechargeable battery
- ◆ USB computer interface
- ◆ Field upgradeable - flash memory
- ◆ Fast warmup time (45 seconds)
- ◆ Comes with NIST traceable calibration  
certificate with data (12 Points)
- ◆ Service tool for anesthesia service  
application (NOT FOR CLINICAL USE)
- ◆ Made in USA

GENERAL	
Model	AA-8100 Series Anesthetic Agent Analyzer
Measurement Technology	NDIR (Non-Dispersive Infrared)
Gases	Sevoflurane, Isoflurane, Desflurane, Halothane, CO <sub>2</sub>
Accuracy	+/- (0.05% Vol% + 4% relative)
Range (Iso, Sevo and Halo)	0 to 8.00%
Range (Des)	0 to 20.00%
Range (CO <sub>2</sub> )	0 to 10.00%
Resolution	0.01%
Detection Minimum	0.15%
Sampling Method	Suction Pump (internal)
Sampling Rate	200 mL/min
Internal Memory	Flash
Interface	USB Device

ELECTRICAL	
AC POWER	90 to 275 VAC, 50/60 Hz
AC POWER ADAPTER	12 VDC, 1.5 A  BC20-21115 (Universal)
BATTERY	Internal Rechargeable Li-Ion battery pack
BATTERY RUNTIME	12 Hours Continuous

PHYSICAL & ENVIRONMENTAL		
DISPLAY	128 X 64 Pixels Graphical LCD, White LED Backlight	
SIZE	7.9 x 6.8 x 3.0 Inches (200 x 173 x 76 mm)	
WEIGHT	< 3.5 Lbs. (1.6 kg)	
CONSTRUCTION	ENCLOSURE	ABS Plastic
	OVERLAY	Back-Printed Lexan
OPERATING RANGE	15 to 40 °C (59 to 104 °F)	
OPERATING ALTITUDE	Up to 10,000 ft	
OPERATING PRESSURE	660 -1200 mBar	
STORAGE RANGE	-20 to 60 °C (-4 to 140 °F)	

# Bluetooth® Wireless Technology

Compatible with  
**myBC mobile**

Bluetooth® & myBC mobile



BC Group is committed to technology and making your life as a Healthcare Technology Professional easy a bit easier. BC Group has been developing new products with **Bluetooth®** wireless technology that integrates with **myBC mobile** app. **Bluetooth®** technology creates a wireless way of operating BC Biomedical brand.

The newest models above feature **Bluetooth®** wireless technology.

Below are upcoming releases later in 2023.



# Bluetooth® Adapters

Bluetooth® & myBC mobile

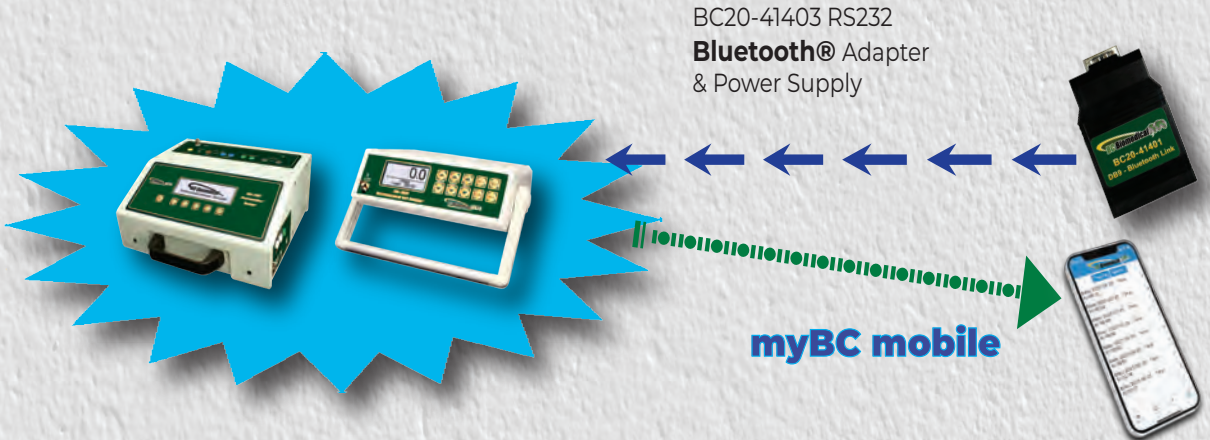

Defibrillator Analyzer

FEATURES

NOW with  
Built-in  
Bluetooth®  
Wireless  
Technology!  
(March 2023)



Compatible with  
**myBC mobile**

Bluetooth®

DA-2006P

- ◆ Tests monophasic, biphasic and pulsed biphasic defibrillators
- ◆ Fully AED compatible
- ◆ Pacer testing capability
- ◆ Internal paddle adapters
- ◆ Printer output
- ◆ Battery or line power
- ◆ 5000 volt, 1000 joule capacity
- ◆ 9 volt battery power
- ◆ Made in USA

**NEW**



\*Previously purchased DA-2006 & DA-2006P Series now upgradable to **Bluetooth®** Wireless Technology with BC20-41401 Adapter. Call our sales department to request upgrade.



# FEATURES

NOW with  
Built-in  
Bluetooth®  
Wireless  
Technology!  
(March 2023)



Compatible with  
**myBC mobile**



 **Bluetooth®**



## DA-2006

- ◆ Monophasic and biphasic compatible
- ◆ Fully AED compatible
- ◆ Pacer testing capability
- ◆ Internal paddle adapters
- ◆ Printer Output
- ◆ Battery or line power
- ◆ 5000 volt, 1000 joule capacity
- ◆ 9 volt battery power
- ◆ Made in USA

**NEW**



\*Previously purchased DA-2006 & DA-2006P Series now upgradable to **Bluetooth®** Wireless Technology with BC20-41401 Adapter. Call our sales department to request upgrade.

Defibrillator Analyzer



## DA-2006P & DA-2006-VL

The DA-2006 and DA-2006P Defibrillator Analyzer Series take advantage of the latest electronic technology and deliver accurate, consistent test results on all defibrillators, regardless of manufacturer or model.

Whether you need to test output energy, cardioversion delay time, maximum energy charge time, or your AED, the DA-2006 and DA-2006P will deliver. You can even capture and view the actual output energy and pacer waveforms to check for any abnormalities.

With 26 internal test loads, the DA-2006P delivers a full range of capabilities for testing the transcutaneous pacemaker function of your advanced level defibrillators, including tests like demand sensitivity, refractory period, rate, pacer pulse width, pacer pulse amplitude, etc. Test pacer functionality with the peace of mind that the Pacer Input terminals on the DA-2006P are internally protected against accidental defibrillator discharge.

DA-2006-VL, works in conjunction with DA-2006 Series Defibrillator Analyzers, providing variable loads used when testing defibrillators to assure the proper electrical current is delivered to the heart, per IEC 60601-2-4 and AAMI DF80 standards. Automatic detection of loads, no settings to change or configure in the DA-2006/P. Ensure that the correct load is selected in the defibrillator output pulse measurement.



DA-2006P

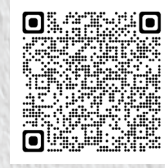

DA-2006-VL

ENERGY OUTPUT MEASUREMENT	
METHOD	Monophasic, Biphasic or Pulsed Biphasic
LOAD RESISTANCE	50 Ω ± 1%, Non-Inductive (< 1 μH)
DISPLAY RESOLUTION	0.1 J
MEASUREMENT TIME WINDOW	100 ms
ABSOLUTE MAX PEAK VOLTAGE	6000 V
PULSE WIDTH	100 ms
CHARGE TIME MEASUREMENT	0.1 to 99.9 s

	HIGH RANGE	LOW RANGE
VOLTAGE	≤ 5000 V	≤ 1000 V
CURRENT	≤ 100 A	≤ 20 A
ENERGY	≤ 1000 J	≤ 50 J
ACCURACY	≤ 100 J ± 2 J	≤ 20 J ± 0.4 J
	> 100 J ± 2% of reading	> 20 J ± 2% of reading
TRIGGER LEVEL	100 V	20 V
PLAYBACK AMPLITUDE	1 mV / 1000 V Lead 1	1 mV / 1000 V Lead 1
TEST PULSE	125 J ± 20%	5 J ± 20%
OSCILLOSCOPE OUTPUT ATTENUATION	1000:1	200:1
CARDIOVERSION	DELAY	0 to 6000 ms
	RESOLUTION	0.1 ms
	ACCURACY	± 2 ms
WAVEFORM PLAYBACK	OUTPUT	LEAD I & PLATES
	SCREEN	200:1 Time Base Expansion
SYNC TIME MEASUREMENTS	TIMING WINDOW	Starts at peak of each R-wave
	TEST WAVEFORMS	All waveform simulations available
	DELAY TIME ACCURACY	± 1 ms

PATIENT SIMULATOR		
ECG WAVEFORM RATES	ECG NSR	30, 40, 45, 60, 80, 90, 100, 120, 140, 160, 180, 200, 220, 240, 260, 280, 300 BPM
	SINE	0.1, 0.2, 0.5, 5, 10, 40, 50, 60, 100 Hz
	SQUARE	0.125, 2.000 Hz
	TRIANGLE	2.000, 2.500 Hz
	PULSE WAVE	30, 60, 120 BPM; 60 ms width
AMPLITUDE	0.5, 1.0, 1.5, 2.0 mV (Lead II)	
ACCURACY	RATE	± 1%
	AMPLITUDE	± 2% @ Lead II
HIGH LEVEL	OUTPUT	200 times Amplitude
	ACCURACY	± 5%
QRS DURATION	80 ms	
LEAD TO LEAD IMPEDANCE	1000 Ω	
ECG ARRHYTHMIA SELECTIONS	Ventricular Fibrillation	
	Atrial Fibrillation	
	Second Degree A-V Block	
	Right Bundle Branch Block	
	Premature Atrial Contraction	
	PVC Early	
	PVC Standard	
	PVC R on T	
	Multifocal PVC	
	Bigeminy	
ECG SHOCK ADVISORY	Run of 5 PVCs	
	Ventricular Tachycardia	
	Asystole	
	Coarse Ventricular Fibrillation	
	Fine Ventricular Fibrillation	
ALGORITHM TEST SELECTIONS	Multifocal Ventricular Tachycardia @ 140 BPM	
	Multifocal Ventricular Tachycardia @ 160 BPM	
	Polyfocal Ventricular Tachycardia @ 140 BPM	
	Polyfocal Ventricular Tachycardia @ 160 BPM	
	SupraVentricular Tachycardia @ 90 BPM	

TRANSCUTANEOUS PACEMAKER ANALYZER				
PULSE RATE	RANGE	30 to 800 ppm		
	ACCURACY	± 1% or 2 ppm (whichever is greater)		
PULSE WIDTH	RANGE	0.6 to 80 ms		
	ACCURACY	± 1% or ± 0.3 ms (whichever is greater)		
VOLTAGE	VARIABLE LOAD INPUT	200 V		
	FIXED LOAD INPUT	15 V		
OSCILLOSCOPE OUTPUT	AMPLITUDE ATTENUATION	0 – 15 V	10,24:1	
		15 – 60 V	41:1	
		> 60 V	164:1	
	MAX OUTPUT	200 V		
DEMAND SENSITIVITY	WAVEFORMS	Square, Triangle, Haversine		
	WIDTH	10, 25, 40, 100, 200 ms		
OUTPUT AMPLITUDE	OUTPUT AMPLITUDE	ECG OUTPUT	0 to 4 mV	
		PACER INPUT (50 TO 400 OHMS)	0 to 10 mV / 50 Ω	
		PACER INPUT (500 TO 2300 OHMS & OPEN)	0 to 100 mV	
		DEFIBRILLATOR PLATES	0 to 10 mV	
		ECG OUTPUT	40 μV	
		PACER INPUT (50 TO 400 OHMS)	40 μV	
OUTPUT RESOLUTION	OUTPUT RESOLUTION	PACER INPUT (500 TO 2300 OHMS & OPEN)	1 mV	
		DEFIBRILLATOR PLATES	0.1 mV	
		ECG OUTPUT	40 μV	
OUTPUT ACCURACY	± 2%			
INPUT RATE	INPUT RATE	ECG OUTPUT	N/A	
		PACER INPUT	30 to 100 ppm	
		DEFIBRILLATOR PLATES	30 to 100 ppm	
REFRACTORY PERIOD	PACING	20 to 500 ms		
	SENSING	20 to 500 ms		
50/60 HZ INTERFERENCE TEST SIGNAL	ACCURACY	± 2 ms		
	ECG OUTPUT	0, 0.24, 0.46, 0.68, 0.91, 1.13, 1.36, 1.58, 1.80, 2.03, 2.25 mV		
PACER INPUT	PACER INPUT	50 Ω	0, 1, 2, 3, 4, 5, 6, 7, 8, 9, 10 mV	
		100 Ω	0.2, 0.4, 0.6, 0.8, 1.0, 1.2, 1.4, 1.6, 1.8, 2.0 mV	
		150 Ω	0.3, 0.6, 0.9, 1.2, 1.5, 1.8, 2.1, 2.4, 2.7, 3.0 mV	
		200 Ω	0.4, 0.8, 1.2, 1.6, 2.0, 2.4, 2.8, 3.2, 3.6, 4.0 mV	
		300 Ω	0.6, 1.2, 1.8, 2.4, 3.0, 3.6, 4.2, 4.8, 5.4, 6.0 mV	
		400 Ω	0.8, 1.6, 2.4, 3.2, 4.0, 4.8, 5.6, 6.4, 7.2, 8.0 mV	
		≥ 500 Ω	0, 1.0, 2.0, 3.0, 4.0, 5.0, 6.0, 7.0, 8.0, 9.0, 10.0 mV	
		DEFIB PLATES	0, 1, 2, 3, 4, 5, 6, 7, 8, 9, 10 mV	
TEST LOAD	LOAD VALUES	50, 100, 150, 200, 300, 400, 500, 600, 700, 800, 900, 1000, 1100, 1200, 1300, 1400, 1500, 1600, 1700, 1800, 1900, 2000, 2100, 2200, 2300 Ω		
	ACCURACY	50 to 1300 Ω	± 1%	
		1400 to 2300 Ω	± 1.5%	
PULSE CURRENT	RANGE	4 to 300 mA (100 Ω load)		
	LIMIT	ACCURACY	± 5% or ± 0.5 mA (whichever is greater)	
		50 – 600 Ω	300 mA	
		700 Ω	286 mA	
		800 Ω	250 mA	
		900 Ω	222 mA	
		1000 Ω	200 mA	
		1100 Ω	182 mA	
		1200 Ω	167 mA	
		1300 Ω	154 mA	
		1400 Ω	143 mA	
		1500 Ω	133 mA	
		1600 Ω	125 mA	
		1700 Ω	118 mA	
		1800 Ω	111 mA	
		1900 Ω	105 mA	
		2000 Ω	100 mA	
2100 Ω		95 mA		
2200 Ω	91 mA			
2300 Ω	87 mA			

# ELECTROSURGICAL UNIT ANALYZER WITH BLUETOOTH® WIRELESS TECHNOLOGY AVAILABLE!\*

ESU Analyzer Series



Compatible with  
**myBC mobile**

## ESU-2400H

DFA2™ Technology  
US Patent No. 9,883,903

The ESU-2400H offers an unprecedented buffer depth of over 16 million samples. This allows for ultra-stable measurements of ESU generator output waveforms and provides future-proofing for new generator output modes such as multiple pulsed waveforms.

The ESU-2400H uses the same base platform as the ESU-2400. This means that you can upgrade your existing analyzer without having to purchase a whole new unit. You have the freedom to get started with the ESU-2400 and then upgrade as the need arises.

The low impedance internal load bank has a range of 0  $\Omega$  to 6400  $\Omega$  in 1  $\Omega$  increments. It is microprocessor-based and utilizes a combination of unique hardware and software to provide accurate and reliable test results, even from “noisy” electro-surgical generator waveforms such as “spray”. The patented DFA2™ Technology utilized in the ESU-2400H allows the system to aggressively digitize the complex RF waveforms produced by electro-surgical generators. Each data point is analyzed to provide highly accurate measurement results.

The ESU-2400H, unlike most conventional ESU Analyzers, has internal high voltage setup relays to control the measurement path. This allows the user to switch between power measurements, Leakage measurements, REM/ARM/CQM testing, or even run an autosequence that could include any or all of these tests.



**NEW**



\*Previously purchased ESU-2400/2400H now upgradable to Bluetooth® wireless technology with BC20-41400 adapter. Call our sales department to request upgrade.

- ◆ US Patent No. 9,883,903
- ◆ The industry's most comprehensive and most accurate full-featured analyzer
- ◆ Measures advanced generator outputs with pulsed RF at up to 3 different amplitudes
- ◆ Patented DFA2™ technology, ultra high speed digitization of multi-pulsed complex RF waveforms
- ◆ 100% compatible with Covidien/Valleylab ForceTriad™, Force FX™, FT10™ and Ligasure™, Conmed System 5000™, and legacy generators by other manufacturers
- ◆ Based upon years of collaborative work with industry leading electrosurgery manufacturers
- ◆ 1% measurement accuracy
- ◆ Free auto-sequences save time and help to ensure compliance
- ◆ Industry standard RF current measurement
- ◆ Continuous & pulsed output waveform compatible
- ◆ Embedded real-time operating system with 5.7" color touch screen display
- ◆ Displays up to 28 different measurement parameters with user selectable and definable screens
- ◆ Internal precision test loads from 0 Ω to 6400 Ω in 1 Ω increments
- ◆ REM/ARM/CQM testing via 500 Ω Adjustable Load in 1 Ω increments
- ◆ PDF test reports
- ◆ USB (3), RS-232, and ethernet communication ports
- ◆ Remote communications capability with ESU generators
- ◆ Made in USA

MEASUREMENTS	
A/D Resolution	14 Bits
A/D Speed	64 MSPS
Bandwidth	50 kHz – 10 MHz
Measurement Accuracy	± 1% Reading
Current Range	2.0 to 700.0 mA RMS (Low Range) 20 to 7000 mA RMS (High Range)
Current Resolution	0.1 mA RMS (Low Range) 1 mA RMS (High Range)
Power Range (Watts)	500 Watts
Power Resolution (Watts)	0.1 Watts
Crest Factor Range	1.4 to 500
Crest Factor Resolution	0.1
Input Voltage Range	0.20 to 70.00 mV RMS (Low Range) 2.0 to 700.0 mV RMS (High Range)
Voltage Resolution	0.01 mV (Low Range) 0.1 mV (High Range)
mV Peak/Peak-to-Peak Range	0.0 to 1.0
mV Peak/Peak-to-Peak Resolution	0.1

Load Bank Specifications	
Internal Setup/Load Selection Relays	10kV, 5A rated Reed Relays
Internal Load Selection	
Internal Load Range	0 to 6400 Ω
Internal Load Accuracy	± 1% Non-inductive
Internal Load Power Ratings	1 Ω: 25 W 2 Ω: 50 W 4 Ω: 100 W Remaining Loads: 225 W
Load Bank Duty Cycle	10 seconds on, 30 seconds off
Load Cooling	Dual 120mm Variable Speed DC Fans
External Load Selection	
External Load Range	0 to 6400 Ω
External Load Resolution	1 Ω

SCREEN SIZE	5.7" QVGA 18 bit color touch screen
SETUP MEMORY	EEPROM, All Parameters
MEMORY RETENTION	10 Years w/o Power
OPERATING RANGE	15 to 30 °C (59 to 86 °F)
STORAGE RANGE	-20 to 60 °C (-4 to 140 °F)
CONSTRUCTION	Enclosure – Aluminum Face – Lexan, Back Printed
SIZE	7.8 x 15.0 x 22.5 inches 198.1 x 381 x 571.5 mm
WEIGHT	31 lbs. (14 kg)
CONNECTIONS	Input: I/O 4mm Safety Jacks 3xUSB, 1xSerial, 1xEthernet 1xPS/2 Keyboard/Mouse Output: 1xBNC Scope Hypertronics 25-pin Footswitch connector
POWER SUPPLY ADAPTER	Input: Universal 100-240 VAC, 50-60 Hz Output: 12 VDC (Specify power cord see page Z)

# PORTABLE ELECTROSURGICAL UNIT ANALYZER WITH BUILT-IN BLUETOOTH WIRELESS TECHNOLOGY!

ESU Analyzer Series



Compatible with **myBC mobile** **ESU-2350**

The ESU-2350 ElectroSurgical Unit Analyzer is a high-accuracy, true RMS RF measurement system designed to be used in the calibration and routine performance verification of electroSurgical generators. It offers a higher degree of accuracy than previously attainable with conventional electroSurgical unit analyzer designs.

The ESU-2350 provides an internal load bank with a range of 0  $\Omega$  to 5500  $\Omega$  in 5  $\Omega$  increments. It is microprocessor-based and utilizes a combination of unique hardware and software to provide accurate and reliable test results, even from “noisy” electroSurgical generator waveforms such as “Spray”.

The DFA™ Technology utilized in the ESU-2350 allows the system to aggressively digitize the RF waveforms produced by electroSurgical generators, analyze each individual digital data point, and provide highly accurate measurement results.



## FEATURES & SPECIFICATIONS

- ◆ Industry standard RF current measurement
- ◆ DFA™ technology ultra high speed digitization
- ◆ 2% measurement accuracy
- ◆ Embedded real-time operating system
- ◆ Touch screen display
- ◆ Displays up to 9 different measurement parameters with user selectable and definable screens
- ◆ Internal precision test loads from 0  $\Omega$  to 5500  $\Omega$  in 5  $\Omega$  increments
- ◆ External test load compatibility
- ◆ Power load curves with multiple power settings per load setting
- ◆ User-definable testing sequences
- ◆ Print test reports to PDF format
- ◆ USB (2) and ethernet communications ports
- ◆ Automatic or manual activation of ESU Generator during power load curve tests
- ◆ 100% compatible with Covidien/Valleylab ForceTriad™, FT10™ and Ligasure™ Generators, and all legacy generators by other manufacturers
- ◆ REM/ARM/CQM testing via 500  $\Omega$  adjustable load in 1  $\Omega$  increments
- ◆ RF Leakage current measurement
- ◆ Made in USA

MEASUREMENTS	
A/D Resolution	14 Bits
A/D Speed	64 MSPS
Bandwidth	10 kHz – 10 MHz
Measurement Accuracy	± 2% Reading
Current Range	2 to 7000 mA RMS
Current Resolution	1 mA RMS
Power Range (Watts)	500 Watts
Power Resolution (Watts)	0.1 Watts
Internal Load Selection	
Internal Load Range	0 to 5500 $\Omega$ , 5 $\Omega$ steps
Internal Load Accuracy	1% ± 0.5 Non-inductive
Internal Load Power Ratings	<50 $\Omega$ : 400 W 50 to <800 $\Omega$ : 500 W ≥800 $\Omega$ : 300 W
Load Bank Duty Cycle	10 seconds on, 30 seconds off
Load Cooling	Dual 120mm Variable Speed DC Fans
External Load Selection	
External Load Range	0 to 5500 $\Omega$
External Load Resolution	1 $\Omega$
SCREEN SIZE	5.7" QVGA 18 bit color touch screen
SETUP MEMORY	EEPROM, All Parameters
MEMORY RETENTION	10 Years w/o Power
OPERATING RANGE	15 to 30 °C (59 to 86 °F)
STORAGE RANGE	-20 to 60 °C (-4 to 140 °F)
CONSTRUCTION	Enclosure – Aluminum Face – Lexan, Back Printed
SIZE	7.8 x 15.0 x 18.5 inches 198.1 x 381 x 470 mm
WEIGHT	18 lbs. (8.2 kg)
CONNECTIONS	Input: I/O 4mm Safety Jacks 2xUSB, 1xEthernet Output: 1xBNC Scope Hirose 12-pin Footswitch connector
POWER SUPPLY ADAPTER	Input: Universal 100-240 VAC, 50-60 Hz Output: 12 VDC (Specify power cord see page Z)

**ESU Analyzer Series**

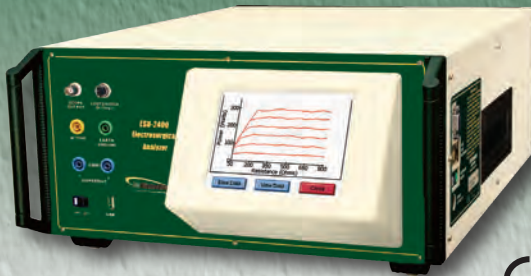
FEATURES

CE

**ESU-2400/H**

**DFA2™ Technology**  
**US Patent No. 9,883,903**

- ◆ 100% compatible with Covidien/Valleylab ForceTriad™, FT10™ and Ligasure™ generators, Conmed System 5000™ generators and all legacy generators by other manufacturers
- ◆ Automated one button ForceTriad™ autosequence included
- ◆ Industry standard RF current measurement
- ◆ 1% measurement accuracy
- ◆ Continuous & pulsed output waveform compatible
- ◆ Embedded real-time operating system with color touch screen
- ◆ Displays up to 28 different measurement parameters with user selectable and definable screens
- ◆ Internal precision test loads from 0  $\Omega$  to 6400  $\Omega$  in 1  $\Omega$  increments
- ◆ REM/ARM/CQM Testing via 500  $\Omega$  adjustable load in 1  $\Omega$  increments
- ◆ Made in USA



ESU-2400H



ESU-2400



CE

**ESU-2350**

- ◆ 100% compatible with Covidien/Valleylab ForceTriad™, FT10™ and Ligasure™ generators, and all legacy generators by other manufacturers
- ◆ Industry-standard RF current measurement
- ◆ Automatic or manual activation of ESU generator during power load curve tests
- ◆ Power load curves with multiple power setting per load setting
- ◆ Displays up to 9 different measurement parameters with user selectable and definable screens
- ◆ Internal precision test loads from 0  $\Omega$  to 5500  $\Omega$  in 5 increments
- ◆ REM/ARM/CQM testing via 500 adjustable load in 1  $\Omega$  increments
- ◆ Made in USA



ESU-2350



Previously purchased ESU-2400/2400H now upgradable to **Bluetooth®** wireless technology with BC20-41400 adapter. Call our sales department to request upgrade.



# FEATURES

# ESU Analyzer Series

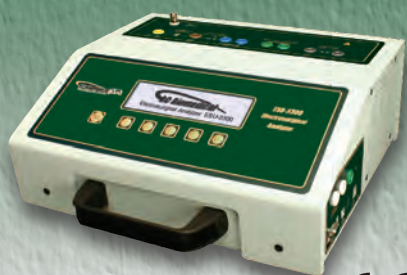

**ESU-2300**



**ESU-2050/P**



**ESU-2000A**

- ◆ Measurements via industry standard current sensing method
- ◆ True RMS readings using DFA™ Technology
- ◆ Built-in RF current transformer
- ◆ Performs output, RF leakage & CQM tests
- ◆ Main test loads from 50 Ω to 750 Ω in 50 Ω steps
- ◆ Auxillary test load - 200 Ω
- ◆ Independent variable CQM test load 1 Ω to 500 Ω in 1 Ω increments
- ◆ External test loads supported
- ◆ Non-inductive internal load resistors
- ◆ Made in USA

- ◆ Smallest and lightest ESU
- ◆ True RMS Readings using DFA™ Technology
- ◆ mV, mV Peak, mA, crest factor and wattage displays
- ◆ 1% measurement accuracy
- ◆ Standard range uses 0.1:1 RF current transformer
- ◆ Special low range uses 1:1 RF current transformer
- ◆ Made in USA

- ◆ Small & Simple-to-use
- ◆ Lightweight
- ◆ 6 selectable loads from 50 Ω to 500 Ω
- ◆ Return contact monitor test with 1 Ω increments
- ◆ RF power, current and leakage measurement
- ◆ Made in USA

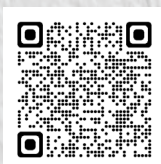

ESU-2300



ESU-2050



ESU-2050P



ESU-2000A



Previously purchased ESU-2300, ESU-2050 and ESU-2050P now upgradable to **Bluetooth®** wireless technology with BC20-41403, which includes both **Bluetooth®** Adapter and Universal Power Supply. Call our sales department to request upgrade.



← For product pricing - please see pages 121 -122 →

# COMPARISON CHART

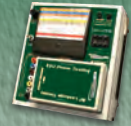
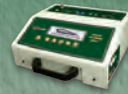

ESU Analyzer Series

Models:	ESU-2400/H	ESU-2350	ESU-2300	ESU-2050/P	ESU-2000A
Industry-standard RF current measurement	Yes	Yes	Yes	Yes	Yes
Test Loads	1 to 6400 Ohms, 1 ohm increments, internal load bank	0 to 5500 Ohms, 5 Ohm steps	50 to 750 Ohms, 50 ohm increments, internal load bank	Requires external precision non-inductive test loads, 1-9999 Ohms compatible	50, 100, 200, 300, 400, 500 Ohms
RF Current Range	2 mA to 7,000 mA	2 to 7000 mA RMS	20 mA to 2,500 mA	<2 mA to 700 mA	0 - 1000 mA
RF Power (Watts RMS) Range	To 999.9 Watts	To 999.9 Watts	To 400 Watts	To 999.9 Watts	To 500 Watts
Bandwidth	10 kHz to 10 MHz	10 kHz to 10 MHz	10 kHz to 10 MHz	10 kHz to 10 MHz	0 - 10 MHz
Display	QVGA Color Touch Screen	QVGA Color Touch Screen	260 X 64 Pixels LCD Graphical Display with Backlight	128 X 64 Pixels LCD Graphical with Backlight	4.5 inch Analog Meter
External Test Load Compatible		Yes, can use internal + external or external only, or internal only		Yes, requires external test loads	Yes
External Current Transformer Required	No	No	No	Yes	No
Continuous Output Waveform Compatibility	Yes	Yes	Yes	Yes	Yes
Pulse Output Waveforms Compatibility	Yes	No	No	2050 No / 2050P Yes	No
Complex Pulsed Waveforms Compatibility	2400H Only	No	No	No	No
Current Measurement Accuracy	± 1% of reading on RMS	± 2% of reading	± 2.5% of reading on RMS	± 1% of reading on RMS	± 2% of Full Scale
Calibration level accuracy	Yes	No	No	Yes	No
Crest Factor Range	1.4 to 500	1.4 to 500	1.4 to 500	1.4 to 500	N/A
Covidien/Valleylab Force Triad Calibration Procedure Compatibility	Yes	Yes	No	Yes	No
Covidien/Valleylab Ligasure Generator Calibration Compatibility	Yes	Yes	No	Yes	No
Number of parameters measured/displayed	ESU-2400: 15 ESU-2400H: 28	9	5	15	2
Internal REM/ARM/CQM Testing	Yes, 500 ohm load adjustable in 1 ohm increments	Yes, 500 ohm load adjustable in 1 ohm increments	Yes, 500 ohm load adjustable in 1 ohm increments	No, requires external CQM Test Box (CQM-2000)	Yes
Automated power-load curves	Yes, "x" to "y" Ohms in "z" ohm increments OR by user-defined load table values, multiple power levels @ each load possible	Yes, "x" to "y" Ohms in "z" ohm increments OR by user-defined load table values, multiple power levels @ each load possible	No	No	No

# COMPARISON CHART

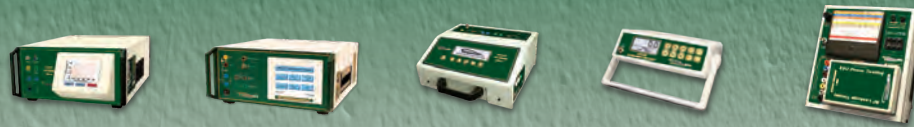

## ESU Analyzer Series

Models:	ESU-2400/H	ESU-2350	ESU-2300	ESU-2050/P	ESU-2000A
Auto-activation of ESU generator for power load curve testing	Yes	Yes	No	No	No
User definable testing autosequences	Yes, unlimited steps with unlimited ascii text description per step, embedded measurement capability within sequence	Yes, unlimited steps with unlimited ascii text description per step, embedded measurement capability within sequence	No	No	No
Communication ports	Network USB, RS232	USB	USB, RS232	USB, RS232	No
Capture & Store RF Waveform	Yes	No	No	Yes	No
RF Leakage Current Measurement	Yes	Yes	Yes	Yes	Yes
Remote control compatibility of ESU generator	Yes	No	No	No	No
User definable data screens	Yes	Yes	Yes	Yes	No
FLASH field upgrade of firmware	Yes	Yes	Yes	Yes	N/A
Test load temperature monitor	Yes	Yes	Yes	No	No
Oscilloscope Output Jack	Yes	Yes	Yes	No	Yes
User-adjustable signal averaging	Yes	Yes	Yes	Yes	No
Test form printout	PDF Only	PDF Only	No	No	No
Browse Internet	Yes	No	No	No	No
Battery Operation	No	No	Yes	No	N/A
External keyboard & mouse compatible	Yes	Yes	No	No	No
Fan Cooling of Internal Load Resistor Bank	Yes	Yes	Yes	No	No
Size	7.8 x 15.0 x 22.5 inches 198.1 x 381 x 571.5 mm	7.8 x 15.0 x 18.5 inches 198.1 x 381 x 470 mm	6.30 x 13.50 x 13.40 inches 160.0 x 342.9 x 340.4 mm	3.4 x 9.1 x 8.0 inches 86.4 x 231.1 x 203.2 mm	5.36 x 8.68 x 9.10 inches 136.1 x 220.5 x 231.1 mm
Weight	≤ 31 lbs. (14 kg)	18 lbs. (8.2 kg)	≤ 17.5 lbs. (7.96 kg)	≤ 3 lbs. (1.36 kg)	≤ 4 lbs. (1.82 kg)

← For product pricing - please see pages 120 -122 →

## PRECISION FLOW ANALYZER

Flow Analyzer



## PFC-3000

The PFC-3000 Series of instruments measures flow, pressure, temperature, humidity and O<sub>2</sub> concentrations bidirectionally. The one-of-a-kind adult, pediatric and high frequency ventilation measuring modes make the PFC-3000 the ideal calibration tool for all ventilators, anesthesia machines and spirometers.

The PFC-3000 distinguishes itself from other calibration tools by combining a simple, intuitive, multilingual user interface with the highest precision. With the push of a button, all measured values can be stored directly on the PFC-3000 and later retrieved for documentation purposes.

## OPTIONAL MULTI-GAS ANALYZER



The MGA-3050 Multi-gas Analyzer connects to any PFC-3000 series flow analyzer and is used to measure anesthetic agent concentrations for testing purposes.

The MGA-3050 measures halothane, enflurane, isoflurane, sevoflurane and desflurane in percentage values. The MGA-3050 also measures percentage values of CO<sub>2</sub> and N<sub>2</sub>O. The MGA-3050 is an excellent instrument for performing vaporizer efficacy tests, but a PFC-3000 series unit is required, since it uses its display to show measurement values.

# SPECIFICATIONS

Flow & Pressure Measurements			PFC-3000A	PFC-3000V	PFC-3000L
Flow	Measuring direction	Range	Accuracy		
			bidirectional		• • •
	Temperature compensated		yes		• • •
	Pressure compensated		yes		• • •
	Humidity compensated		yes		• • •
	O2 compensated		yes		• • •
Pressure	High	± 300 L/min	± 1.75%* or ± 0.1 L/min**		• • •
	Low	± 20 L/min	± 1.75%* or ± 0.04 L/min**		• • •
	High	0 – 145 PSI	± 1%* or ± 0.15 PSI**		• • •
	Average	± 112.5 mmHg	± 0.75%* or ± 0.08 mmHg**		Differential Relative Relative
	Low	0 – 3.75 mmHg	± 1%* or ± 0.01 mmHg**		• • •
	High Flow Port	0 – 112.5 mmHg	± 0.75%* or ± 0.08 mmHg**		• • •
Measuring unit	Flow	L/min, L/s, cfm, mL/min, mL/s			• • •
	Pressure	bar, mbar, cmH <sub>2</sub> O, inH <sub>2</sub> O, Torr, inHg, hPa, kPa, mmHg, PSI			• • •
<b>Additional Measuring Values</b>					
Oxygen	Concentration	0 - 100%	Accuracy ± 1% O <sub>2</sub> **		• • •
	Pressure compensated		yes		• • •
Temperature	High Flow Port	0 - 50°C	± 1.75%* or ± 0.5°C**		• • •
Dew point	High Flow Port	-10 - 50°C	± 2%* or ± 1°C**		• • •
Air humidity	High Flow Port	10 - 80% RH	± 3%		• • •
		<10% and >80% RH	± 5%		• • •
CO <sub>2</sub>	Concentration	0 - 10%	± (0.2% ABS + 2% REL)		w/ MGA-3050 w/ MGA-3050 w/ MGA-3050
		10 - 20%	± (0.3% ABS + 4% REL)		w/ MGA-3050 w/ MGA-3050 w/ MGA-3050
N <sub>2</sub> O	Concentration	0 - 100%	± (2% ABS + 2% REL)		w/ MGA-3050 w/ MGA-3050 w/ MGA-3050
HAL, ISO, ENF	Concentration	0 - 8%	± (0.15% ABS + 5% REL)		w/ MGA-3050 w/ MGA-3050 w/ MGA-3050
		8 - 12%	± (0.2% ABS + 10% REL)		w/ MGA-3050 w/ MGA-3050 w/ MGA-3050
SEV	Concentration	0 - 10%	± (0.15% ABS + 5% REL)		w/ MGA-3050 w/ MGA-3050 w/ MGA-3050
		10 - 15%	± (0.2% ABS + 10% REL)		w/ MGA-3050 w/ MGA-3050 w/ MGA-3050
DES	Concentration	0 - 22%	± (0.15% ABS + 5% REL)		w/ MGA-3050 w/ MGA-3050 w/ MGA-3050
		22 - 25%	± (0.2% ABS + 10% REL)		w/ MGA-3050 w/ MGA-3050 w/ MGA-3050
Gas types		Air, Air/O <sub>2</sub> , N <sub>2</sub> O/O <sub>2</sub> , Heliox (21% O <sub>2</sub> ), He/O <sub>2</sub> , N <sub>2</sub> , CO <sub>2</sub> , customized gas types		• • •	
Gas Conditions		ATP, ATPD, ATPS, AP21, STP, STPH, BTPS, BTPD, 0/1013, 20/981, 15/1013, 25/991, 20/1013		• • •	
<b>Respiratory Parameters</b>					
Rate		1 - 1000 bpm	Accuracy ± 2.5%** or ± 1 bpm		• • •
Time	T <sub>I</sub> , T <sub>E</sub>	0.05 - 60 s	± 0.02 s		• • •
I:E ratio		1:300 - 300:1	± 2.5%*		• • •
T <sub>I</sub> /T <sub>total</sub>		0 - 100%	± 5%*		• • •
Breath volumes	V <sub>ti</sub> , V <sub>te</sub> (@Flow Low)	± 10 L	± 1.75%* or ± 0.10 mL(>2.4 L/min)		• • •
	V <sub>ti</sub> , V <sub>te</sub> (@Flow High)	± 10 L	± 1.75%* or ± 0.20 mL(>6.0 L/min)		• • •
Minute volumes	V <sub>i</sub> , V <sub>e</sub>	0 - 300 L/min	± 2.5%* or ± 20 mL/min(High) ± 10 mL/min(low)		• • •
Pressure	P <sub>peak</sub> , P <sub>mean</sub> , P <sub>EEP</sub> , P <sub>plateau</sub>	0 – 152.96 cmH <sub>2</sub> O	± 0.75%* or ± 0.1 cmH <sub>2</sub> O**		• • •
Peakflow	Peakflow Insp./Exp.	± 300 L/min	± 1.75%* or ± 0.1 L/min**		• • •
Compliance	C <sub>stat</sub>	0 - 1000 mL/mbar	± 3%* or ± 1 mL/mbar**		• • •
Trigger	Adult, Pediatric, HFO	Adjustable on flow or pressure curves with user-defined limits.		• • •	
<b>General Information</b>					
Electrical & Physical Data	AC input	100 - 240 VAC, 50/60 Hz		• • •	
	Battery (lead rechargeable battery)	3 hrs (with MGA-3050 2 hrs)		• • •	
	Power consumption	25 VA(W)		• • •	
	Weight	<8.5 Lbs (3.8 kg)		• • •	
	Dimensions (w x d x h)	8.67 x 9.84 x 4.72 inches (220 x 250 x 120 mm)		• • •	
Data Storage		all parameters (measured as well as respiratory values)		• • •	
Display	Graphic display	Intuitive user interface with numerical measuring values, statistics, volume trigger configuration, gas type selection and calibration menus.		• • •	
Communication Interfaces		USB for Windows Software FlowLab, Interfaces RS-232 for individual communication, TTL for external trigger.		• • •	
Calibration		annually		• • •	
Conditions	Ambient temperature	15 - 40 °C (59 - 104 °F)		• • •	
	Humidity	10 - 90% RH, Non-condensing		• • •	
Approvals		CE, CSA		• • •	

Legend  
 \* Tolerance related to the measured value  
 \*\* Absolute tolerance (Whichever is greater)

# SINGLE-CHANNEL INFUSION PUMP ANALYZER WITH BUILT-IN BLUETOOTH® WIRELESS TECHNOLOGY!

Infusion Pump Analyzer

**NEW**



CE

Compatible with  
**myBC mobile**

**IPA-3100**

**Bluetooth®**

The IPA-3100 is the most compact, feature dense single channel analyzer on the market. It is a high accuracy, easy-to-use system that incorporate full touch screen control with an intuitive interface.

Our Patented design uses a dual syringe stepper motor driven system that provides continuous monitoring of the fluid flow without the need to stop and perform intermittent drains like older technologies do. This provides a more realistic flow path for the Infusion Device under test and therefore more accurate readings.

The IPA-3100 has configurable test parameters which allows for specific test routines specified by various manufacturers. Tests can be stored manually or automatically up to 250 different records. These test records can be downloaded to a computer to then create reports that can be printed.

The IPA-3100 is **Bluetooth®** capable to allow for wireless testing and control. With the use of **myBC mobile** or BC Flow, multiple test configurations can be stored for quick testing. Records of each test can be created and then saved for later viewing and analysis. Reports can also be generated from test records for in-depth analysis and/or traceability.



# SPECIFICATIONS

FLOW MEASUREMENTS		
Flow Rate	0.01 mL/hr to 1000 ml/hr	
Flow Resolution	0.01 mL/hr	
Accuracy (After 30 Seconds)	1% reading + 0.005 mL/hr	0.1 to 9.9 ml/hr
	1% of reading	10 to 700 ml/hr
	2% of reading	700-1000 ml/hr
Back-Pressure	0.200 PSI	
Minimum Volume	0.05 mL	
Measurement Rate	10 Hz	

VOLUME MEASUREMENTS	
Range	0 to 2000 mL
Resolution	0.001 mL
Accuracy	1% reading after 0.100 mL

PRESSURE MEASUREMENT	
Range	-5 to 50 PSI
Resolution	0.001 PSI
Accuracy	0.1% FS
Pressure Units	PSI (Default), mmHg, mBar, kPa
Measurement Rate	10 Hz

ELECTRICAL	
AC POWER	100-240 VAC, 50/60 Hz
AC POWER ADAPTER	12 VDC, 1.5 A BC20-21115 (Universal) 
BATTERY	Internal Rechargeable Li-Ion battery pack
BATTERY RUNTIME	12 Hours Idle, 3-4 Hours Continuous Testing

PHYSICAL & ENVIRONMENTAL		
DISPLAY	4.3" Color Touch screen	
SIZE	6.2" x 4.8" x 4.3" (L x W x H)	
WEIGHT	<3lbs. (1.4 kg)	
CONSTRUCTION	ENCLOSURE	ABS Plastic
	OVERLAY	Back-Printed Lexan
OPERATING RANGE	15 to 40 °C (59 to 104 °F)	
STORAGE RANGE	0 to 50 °C (32 to 122 °F)	

**NEW****FEATURES****Infusion Pump Analyzer****THE IPA-3100 IS COMPACT-INTUITIVE-EASY-TO-USE!**

- ◆ Small Footprint
- ◆ Integrated Stylus
- ◆ Easy to Use
- ◆ Intuitive Interface
- ◆ High Accuracy
- ◆ 4.3" Color Touch Screen
- ◆ Smooth Dual Syringe System  
Eliminates Drain  
Cycle Inconsistencies
- ◆ Whisper Quiet Operation
- ◆ Automatic Start
- ◆ Built-in Data Collection  
(250 Records with  
Detailed Asset Information)
- ◆ PDF Reports available through  
BC Flow (PC Software)
- ◆ Industrial Grade SS  
Pressure Sensor
- ◆ 0.1 mL/Hr to 1000 mL/Hr
- ◆ Micro USB Port
- ◆ PC Compatible
- ◆ Rechargeable Battery
- ◆ Configurable Pressure Unit  
(PSI, mmHg, mBar, kPa)
- ◆ **Bluetooth®** wireless technology with  
myBC Mobile App (Android/iOS)





**NEW**

**THE IPA-3100 IS PORTABLE & HIGHLY ACCURATE!**

**Infusion Pump Analyzer**

**NEW**

# Infusion Pump Analyzer

## IPA-3100

- Easy To Use
- 4.3" Color Touch Screen
- Smooth Dual Syringe System
- Automatic Start
- Whisper Quiet Operation
- Industrial Grade Pressure Sensor
- Micro USB Port
- BLUETOOTH® Wireless Technology



**\$3,250**



Scan QR Code for more information or to purchase

The IPA-3100 is the most compact, feature dense single channel analyzer on the market.

Our patented design uses a dual syringe stepper motor driven system that provides continuous monitoring of the fluid flow without the need to stop and perform intermittent drains like older technologies do.



Android



IOS



**myBCmobile**

# MULTI-CHANNEL INFUSION PUMP ANALYZER WITH BLUETOOTH® UPGRADE AVAILABLE!\*

## Infusion Pump Analyzer

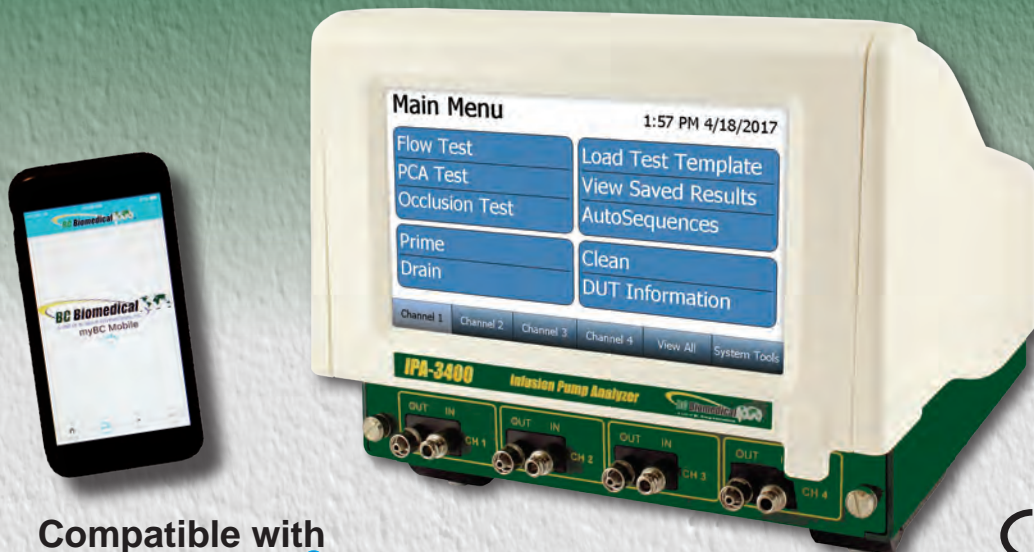

Compatible with  
**myBC mobile**

**IPA-3400**  
US Patent No. 10,100,828



The IPA-3400 is a high accuracy, easy-to-use system that incorporates full touch screen control of all processes.

This new cutting edge, patented design uses a dual-syringe stepper motor driven system that provides continuous monitoring of the fluid flow without the need to stop and perform intermittent drains like older technologies do. This provides a more realistic flow path for the Infusion device under test and therefore more accurate readings. Also, independent stepper motor control of the custom designed ceramic valving allows the system to run not only more quietly and more smoothly, but it also allows for a powered fluid flow for use in the built-in cleaning cycle.

The IPA-3400 has built-in auto-sequence capabilities that allows the user to perform automatic test procedures. This allows specific test routines specified by various manufacturers to be run, which provides a significant time savings as well as reduces the risk of human error.

All test results are stored internally in the large 32GB memory. They can also be downloaded to a USB flash drive.

There are specific requirements in IEC 60601-2-24 for not only flow readings but back pressure simulation, bolus (PCA) measurements and occlusion alarm monitoring. All of these features are specifically built into the IPA-3400 with simple to use on screen selections.

**NEW**



\*Previously purchased IPA-3400 now upgradable to **Bluetooth®** wireless technology with BC20-41400 adapter. Call our sales department to request upgrade.

# SPECIFICATIONS

Parameter		IPA-3400		
Flow Measurement	Display Range (mL/hr)	0.01 - 2600		
	Flow Rate (mL/hr)	0.10 - 1600		
	Flow Resolution (mL/hr)	0.010 (10 µL/hr)		
	Accuracy	+/-1% rdg + 1LSD	0.1 to 9.9 mL/hr	
		+/-1% rdg	10 to 700 mL/hr	
		+/-2% rdg	700 to 1600 mL/hr	
	Min Volume (mL)	0.05 (50 µL)		
	Channels	1, 2, 3 or 4 (user-installable)		
Volume Measurement	Volume Range (mL)	0 to 9999		
	Volume Resolution (mL)	0.001 (1.0 µL)		
	Volume Accuracy	+/-1% rdg +/- 20µL, after 100 µL		
PCA/Bolus Measurement	Display Range (mL)	0.1 to 100		
	Measurement Range (mL)	0.5 to 100		
	Accuracy	+/- 1%		
	Min Bolus Volume (mL)	0.01 (10 µL)		
Elapsed Time	Range	0 - 120 Hours		
	Resolution	1 Second		
	Accuracy	0.5 Second		
Occlusion (Pressure) Test	Range	-258.57 to 2585.75 mmHg (-5 to 50 PSI)		
	Resolution	0.05 mmHg (0.001 PSI)		
	Accuracy	0.1% FS		
Back-Pressure Control	Range	-200 to 600 mmHg (-3.867 to 11.602 PSI)		
	Resolution	0.05 mmHg (0.001 PSI)		
	Accuracy	0.1% FS		
Pressure Units	Selectable	mmHg, PSI, bar, kPa		
Interface	Fluid Fittings	Inlet	Female Luer	
		Drain	Male Luer Lock	
		Ports	4 x USB-A Host ports	
	USB	Supported Devices	HID-compliant Keyboard, Mouse & Barcode Scanner	
			Flash Drives	
	AUX	Ports	4 (1 per channel)	
Display	7" Color Touch Screen (800 x 480)			
Power Supply	Voltage	Input - 90 to 264 VAC, 50/60 Hz, 90VA		
Weight	1 channel < 8 lbs 2 channel < 10 lbs 3 channel < 12 lbs 4 channel < 14 lbs			
Size (H x W x D)	7.8 (H) x 9.1 (W) x 10.2 (D)			
Storage Temperature	0 to 50 °C			
Operating Temperature	15 to 40 °C			
Data Storage	Internal 32 GB			

## FEATURES

# Infusion Pump Analyzer



## IPA-3400

- ◆ US Patent No. 10,100,828 smaller in size - larger in features
- ◆ Whisper quiet operation with rapid processing
- ◆ High accuracy
- ◆ Large 7" color touch screen
- ◆ 1,2,3 and 4 channel models available (field upgradable)
- ◆ User swappable fully self contained flow modules
- ◆ Calibration in flow modules
- ◆ Smooth dual syringe system eliminates drain cycle inconsistencies
- ◆ Auto start & test sequences
- ◆ Built in data collection
- ◆ PDF reports available
- ◆ Industrial grade SS pressure sensor
- ◆ Performs all IEC 60601-2-24 required tests
- ◆ 0.1 mL to 1600 mL/Hr
- ◆ 4 USB ports, 4 AUX ports
- ◆ Large 32GB internal memory
- ◆ Flash drives, barcode scanners, keyboard and mouse directly supported
- ◆ Configurable pressure (mmHg, PSI, Bar, kPa)
- ◆ PCA/Bolus
- ◆ Back pressure simulation
- ◆ Trumpet curve analysis (BC Flow)
- ◆ Data download to flash drive
- ◆ Customizable test templates (built-in)
- ◆ Self-cleaning cycle



## IPA-3900-FM

The IPA-3400 is designed to hold up to 4 IPA-3900-FM flow modules. These modules are individually serialized and calibrated so that they may be moved from channel to channel and even unit to unit. Once installed they are recognized by the IPA-3400 and their serial number and NIST traceable calibration information are presented on the display and utilized in all data reporting.

The interchangeable modules provide the user with unprecedented flexibility in their IPA testing system. There is no need to be down when the unit is due for calibration. Only the modules need to be calibrated. This also allows the rotating of modules or the use of a spare module, thus providing flexibility not available in other systems. The same is true for service. If there is a problem on one channel, only the module needs to be serviced, eliminating downtime.

The IPA-3400 display may be raised to gain full access to the four user swappable flow modules. No wiring or plumbing is required for module installation. Simply lift the display, remove the cover plate, loosen the retainer screw and slide the module out. All plumbing and electronics are self-contained and all electrical connections are made via a slide-in mating connector on the end of the module. Then just reverse the process for installation.

The IPA-3400 allows for easy field expansion. You can buy a one channel unit and later purchase additional modules that can be added in the field. Just plug them in and the system will automatically recognize the additional module(s), reconfigure itself and you are ready to go. Made in USA.

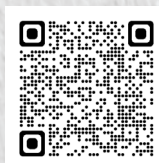

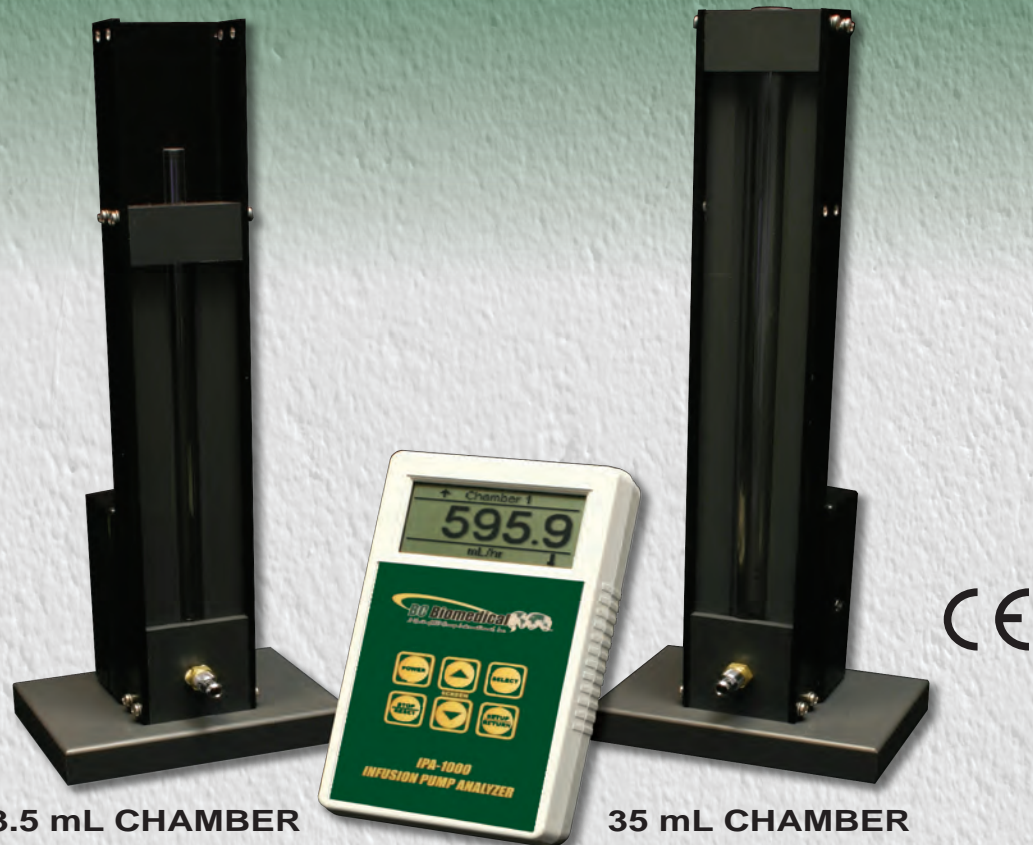

3.5 mL CHAMBER

35 mL CHAMBER

## IPA-1000

The IPA-1000 Infusion Pump Analyzer Family is designed to test the flow rates of intravenous infusion pumps to ensure their correct operation. The IPA-1000 is able to test up to two pumps simultaneously by the volumetric method in milliliters per hour.

All tests are controlled by a microprocessor, which calculates and displays the results. The fluid path is unobstructed, making it easy to clean. The tubes are plastic, not glass so they are rugged. The cables and chambers are interchangeable.

The unit auto identifies each chamber when it is plugged in. The chamber calibration is stored electronically in each chamber, so all units are interchangeable. Units are designed to be simple, portable and user friendly.



- ◆ Easy-to-use
- ◆ Easy-to-clean
- ◆ Simultaneous operation of two chambers
- ◆ Large graphic display with cursor
- ◆ Selection of options & setup of parameters
- ◆ Auto chamber recognition
- ◆ 2 chamber sizes (3.5 & 35 mL)
- ◆ Out-of-sequence sensing
- ◆ Battery display (0 to 100%)
- ◆ Similar function to Dynatech

Nevada Model 404A

- ◆ Ranges 0 to 999.9 mL/hr & 0 to 9999 mL/hr
- ◆ ± 1% of reading flow accuracy
- ◆ Digital calibration – No pots to turn
- ◆ Software adjustable contrast
- ◆ Replaceable tubes
- ◆ Sealed level sensors
- ◆ Programmable end of test audio
- ◆ Programmable auto or manual test start
- ◆ Made in USA

<u>BC Model</u>	<u>Description</u>
BC10-03103	IPA-1000, (1) 3.5 mL Chamber, (1) Interconnect cable
BC10-03104	IPA-1000, (1) 35 mL Chamber, (1) Interconnect cable
BC10-03105	IPA-1000, (2) 3.5 mL Chambers, (2) Interconnect cables
BC10-03106	IPA-1000, (2) 35 mL Chambers, (2) Interconnect cables
BC10-03107	IPA-1000, (1) 3.5 mL Chamber, (1) 35 mL Chamber, (2) Interconnect cables





LS-2000 A / I / E



LS-1000M

BC Biomedical's Lung Simulator Series are affordable, ultra-portable and easy-to-maintain alternatives to older models.

The LS-2000A and LS-2000I SmartLung(s) are available in adult (A) and infant (I) models, offering all the performance and features of large and expensive test lungs in a compact, easy-to-use package. The LS-1000E EasyLung is a simple, low-cost, general purpose test lung with no variable controls, LS-1000M is the ideal tool to test neonatal and infant ventilators.

The BC Biomedical LS-1000E EasyLung provides a broad spectrum of benefits to the respiratory care field. It is ideal for ventilator manufacturers validating the safety of their products, for ventilator training and for biomedical engineers performing general service procedures. The LS-1000E combines singular design with high-quality, replaceable parts. Its unique double-conus multi-connector also ensures a direct connection to all tubing systems.

The LS-2000A and LS-2000I are unbeatable in terms of price/performance ratio. Resistance (airway resistance), lung compliance and leakage are all adjustable. Their respective sizes eliminate the cumbersome side tables needed by large test lungs. Different bag sizes ensure that virtually all patient lungs can be simulated; from babies to adults. SmartLung(s) do not require any additional adapters and the leak simulation is infinitely adjustable. The SmartLung enables verification of premature baby ventilators as well as mask ventilation. Even the sensitive function of patient flow triggering can be tested with the SmartLung.





## LS-1000 & LS-2000 Series

- ◆ Easy-to-use
- ◆ Ultra-portable (< 1 Lbs)
- ◆ Quick disassembly
- ◆ Simple design
- ◆ Replacement parts available
- ◆ All components can be sterilized
- ◆ Connects directly to your ventilator's existing tubing

### LS-2000 Series Features

- ◆ Adjustable compliance settings
- ◆ Adjustable resistance settings
- ◆ Variable leakage valve
- ◆ Simple design
- ◆ Fraction of the price and size of any comparable lung sim

### LS-1000E Features

- ◆ Unique double-conus connector (OD 22 conical, OD 15 conical)
- ◆ Unbeatable simplicity & price

### LS-1000M Features

- ◆ Ideal tool to test neonatal and infant ventilators



Models	LS-1000E	LS-2000I	LS-2000A	LS-1000M
Use	General Purpose	Infant	Adult	Infant/Neonate
Resistance	20 mbar/L/s	5, 20, 50, 200 mbar/L/s	5, 20, 50, 200 mbar/L/s	--
Compliance	25 mL/mbar (Vt = 500mL, PEEP = 0 mbar)	1, 2, 3, 5 mL/mbar	10, 15, 20, 30 mL/mbar	0.7 mL/mbar @ Vt = 20mL
Volume	0-1000 mL (with 1L bag)	0-200 mL (with 0.5L bag)	0-600 mL (with 1L bag)	0-20mL
Leak	N/A	0-10 L/min	0-10 L/min	--
Weight	< 0.5 Lbs (0.23 kg)	< 0.7 Lbs (0.32 kg)	< 0.8 Lbs (0.36 kg)	25g
Dimensions (LxWxH)	11.9" x 4.6" x 1.7" (302.3 x 116.8 x 43.7 mm)	10.7" x 4.6" x 1.6" (271.8 x 116.8 x 40.6 mm)	11.9" x 4.6" x 1.6" (302.3 x 116.8 x 40.6 mm)	150 x 45 x 45mm
Replaceable Components	Yes	Yes	Yes	--
Sterilizable	Yes	Yes	Yes	Yes, at 134°C

# PRECISION NON-INVASIVE BLOOD PRESSURE ANALYZERS

41

NIBP Blood Pressure Series



Compatible with  
**myBC mobile**



NIBP-1040KIT-E  
PICTURED

## NIBP-1000 SERIES



The NIBP-1040 along with our other NIBP-1000 Series devices are Microprocessor based, high quality and precision Non-Invasive Blood Pressure (NIBP) simulators and manometers.

The units in our NIBP-1000 Series are small, easy to use and have multiple features to fit many different applications. With an optional fully charged rechargeable NiMH battery, the NIBP has greater portability and capable of performing hundreds of tests.

The BC Biomedical NIBP-1020 features simulation of ECG, pace, respiration and performance waveforms. The 1030 model includes these, as well as simulation of Invasive Blood Pressure (IBP), temperature, arrhythmia and leak detection.

The NIBP-1040 includes everything in the BC Biomedical NIBP 1010- NIBP-1030 models PLUS extended lead connectors, cardiac output, fetal/maternal, internal battery, peak detection and an alarm. NIBP-1040-KIT above is shown with a cardiac output module, also known as the MCO-2100 breakout box and 6 adapters. Also included in the NIBP-1040 kit: battery eliminator, soft case, and NIST calibration certificate.

**NEW**



\*Previously purchased NIBP-1000 Series now upgradable to Bluetooth® wireless technology using BC20-41402 adapter. Call our sales department to request upgrade.

**Blood Pressure**

Pressure Range:  $\pm 500$  mmHg @ 20 °C (68 °F)  
 Accuracy:  $\pm (1\%$  of Reading + 0.5 mmHg)  
 Simulation Rate: 80, 94 BPM (synchronized to ECG)  
 Accuracy:  $\pm 1\%$

**Invasive Blood Pressure**

Static Pressure: -10, -5, 0, 20, 40, 50, 60, 80, 100, 120, 150, 160, 200, 240, 250, 300, 320, 400 mmHg  
 Accuracy:  $\pm (1\%$  Full Range + 1 mmHg) or  $\pm (2\%$  Setting + 2 mmHg)  
 Impedance: 300  $\Omega$  ( $\pm 10\%$  Accuracy)  
 Excitation Range: 2 to 16 Vrms Excitation  
 Frequency: DC to 5 kHz  
 Sensitivity: 5 or 40  $\mu$ V/V/mmHg

**ECG NSR**

Rate: 30, 60, 120, 240 BPM  
 ( $\pm 1\%$  Accuracy)  
 Amplitude: 2.75 mV ( $\pm 2\%$  @ Lead II Accuracy)

**ECG Performance**

Sine Wave: 10, 60, 100 Hz  
 Square Wave: 0.125, 2.000 Hz  
 Triangle Wave: 2.000 Hz  
 Rate Accuracy:  $\pm 1\%$   
 Amplitude: 2.75 mV ( $\pm 2\%$  @ Lead II Accuracy)

**Pacemaker Waveforms**

Amplitude: 3 mV ( $\pm 10\%$  Accuracy)  
 Width: 6 ms ( $\pm 5\%$  Accuracy)

**Respiration**

Rate Accuracy:  $\pm 1\%$   
 Impedance: Delta 3.0  $\Omega$  ( $\pm 10\%$  Accuracy)  
 Baseline: 1000  $\Omega$  ( $\pm 5\%$  Accuracy)

**Temperature**

Settings: 0, 24, 30, 37, 40, 42 °C ( $\pm 0.1$  °C Accuracy)  
 Type: YSI Series 400 and 700

**Fetal/Maternal**

Fetal heart rate: 60, 90, 120, 140, 150, 210, 240 BPM  
 IUP Period: Single Contraction (Manual) 2, 3, 5, Min (AUTO)  
 FHR (During Contraction): Uniform Deceleration  
 Early Deceleration Late Deceleration Uniform Acceleration

**Cardiac Output**

Injectate  
 Temperature: 0, 24 °C (32, 75.2 °F)  
 Injectate Flow: 2.5, 5.0, 10.0 L/MIN  
 Other Outputs: Faulty – Injectate  
 Left-to-Right Shunt  
 Calibrated Temperature Pulse



## NIBP-1010

- ◆ +/- 1% of reading pressure accuracy
- ◆ Digital pressure envelope offset
- ◆ Optional peak pressure detect with simple reset
- ◆ SpO2 ready – compatible with msp-2100 module
- ◆ Digital calibration – no pots to turn
- ◆ Made in USA



NIBP-1010



## NIBP-1020

### Includes NIBP-1010 Features Plus:

- ◆ ECG output with full NSR waveform
- ◆ Sinusoidal respiration simulation
- ◆ ECG test waveforms
- ◆ Pace waveform
- ◆ Optional peak pressure detect with ECG alarm test
- ◆ ECG synchronized with blood pressure
- ◆ Made in USA



NIBP-1020



## NIBP-1030

### Includes NIBP-1020 Features Plus:

- ◆ Synchronized invasive blood pressure output
- ◆ Selectable IBP sensitivity 5/40  $\mu\text{v/v/mmHg}$
- ◆ Static IBP simulation –10mmHg to 400 mmHg
- ◆ ECG arrhythmia waveforms
- ◆ ECG arrhythmia sequence
- ◆ YSI 400 and 700 Series Temperature Simulator
- ◆ Made in USA



NIBP-1030



## NIBP-1040

### Includes NIBP 1030 Features Plus:

- ◆ Fetal/maternal
- ◆ Extended lead
- ◆ Cardiac output
- ◆ Internal battery
- ◆ Peak pressure detect with ECG alarm test included
- ◆ Kit Complete
- ◆ Made in USA



NIBP-1040

**NIBP-1010, NIBP-1020 & NIBP-1030 ALSO AVAILABLE IN KITS!**

## COMPARISON CHART

BC Biomedical NIBP Series Features				
Features	1010	1020	1030	1040
NIBP Sim	Included	Included	Included	Included
Manometer	Included	Included	Included	Included
SpO2	Optional	Optional	Optional	Optional
ECG Sim	N/A	Included	Included	Included
Patient Sim	N/A	N/A	Included	Included
Pace	N/A	Included	Included	Included
Respiration	N/A	Included	Included	Included
Performance Waveforms	N/A	Included	Included	Included
IBP	N/A	N/A	Included	Included
Temp	N/A	N/A	Included	Included
Arrhythmia	N/A	N/A	Included	Included
Leak Detect	N/A	N/A	Included	Included
Extended Lead	N/A	N/A	Optional	Included
Cardiac Output	N/A	N/A	N/A	Included
Fetal/Maternal	N/A	N/A	N/A	Included
Internal Battery	Optional	Optional	Optional	Included
Peak Detect	Optional	Optional	Optional	Included
Alarm	N/A	Optional	Optional	Included

### Optional Accessories

Soft Carrying Case  
 Bulb Adapter  
 NINAMAP/Critikon Adapter  
 Quick Disconnect Adapter

Luer Adapter  
 Marquette Adapter  
 Pulse Oximetry Module / FSX-1101  
 FingerSim™ Replacement Set

# CONTINUOUS RELIABLE OXYGEN MEASUREMENT

45

Oxygen Analyzer Series



OGX-1900-A



OGX-1900-M



OGX-1800-A

## OGX-SERIES

The OGX-Series oxygen analyzers & monitors are intended for short term use in combination with therapeutic devices such as lung ventilators and incubators; monitoring vital physiological processes and parameters such as respiration, anesthesia, intensive or emergency care; monitoring the administration of gases using ventilators, anesthesia machines, hyperbaric chambers and medical gas mixers.

The OGX-Series oxygen analyzers & monitors measure and display an independent secondary confirmation of the oxygen concentration in breathing gas mixtures administered by other devices.

The OGX-1900 oxygen analyzers and monitors can be positioned on a table top or pole (tripod wire stand and V-mount dovetail attachments are mounted on the back of the device) and are readily portable from one location to another. They provide continuous, fast, reliable and accurate oxygen measurements of up to respiratory care systems.

The OGX-1800-A is a palm sized oxygen analyzer that measures 0.05% to 100% oxygen over a 32 month operating life with no maintenance.



OGX-1900-A



OGX-1900-M



OGX-1800-A

# SPECIFICATIONS

	OGX-1900-A	OGX-1900-M	OGX-1800-AR	OGX-1800-A
<b>Measurement Range</b>	0-100% oxygen	0-100% oxygen	0-100% oxygen	0-100% oxygen
<b>Accuracy</b>	<±2% of range at constant conditions	<±2% of range at constant conditions	<±2% of range at constant conditions	<±2% of range at constant conditions
<b>Response Time</b>	T90 < 10 seconds	T90 < 10 seconds	T90 < 10 seconds	T90 < 10 seconds
<b>Sensitivity (LDL)</b>	0.1%	0.1%	0.1%	0.1%
<b>Linearity</b>	< 2% of scale	< 2% of scale	< 2% of scale	< 2% of scale
<b>Sensor</b>	All-11-60 (A model)	All-11-60	All-11-75-PO2R	All-11-75-PO2R
<b>Sensor Life at 25 degrees C (77 degrees F) and 1 atm</b>	60 months in air	60 months in air	32 months in air	32 months in air
<b>Calibration Interval</b>	After 8 hours of use	After 8 hours of use	After 8 hours of use	After 8 hours of use
<b>Inlet Pressure</b>	Ambient 0.34 -2 barg (5-30 psig) with atmospheric vent	Ambient 0.34 -2 barg (5-30 psig) with atmospheric vent	Ambient 0.34 -2 barg (5-30 psig) with atmospheric vent	Ambient 0.34 -2 barg (5-30 psig) with atmospheric vent
<b>Flow Rate</b>	0.2 - 10 NI/m (0.4- 20 SCFH)	0.2 - 10 NI/m (0.4- 20 SCFH)	0.2 - 10 NI/m (0.4- 20 SCFH)	0.2 - 10 NI/m (0.4- 20 SCFH)
<b>Gas Connections</b>	1 x 16 mm thread or push-in flow diverter with o-ring seal	1 x 16 mm thread or push-in flow diverter with o-ring seal	1 x 16 mm thread or push-in flow diverter with o-ring seal	1 x 16 mm thread or push-in flow diverter with o-ring seal
<b>Display</b>	3 1/2 digit backlit LCD 7 x 3.5 cm (2.75 x 1.375"); resolution 0.1	3 1/2 digit backlit LCD 7 x 3.5 cm (2.75 x 1.375"); resolution 0.1	3 digit LCD 2.8 x 1.6 cm (1.1 x 0.625"); resolution 0.1	3 digit LCD 2.8 x 1.6 cm (1.1 x 0.625"); resolution 0.1
<b>Dimensions</b>	9.1 x 14.9 x 4 cm (3.6 x5.9 x 1.6")	9.1 x 14.9 x 4 cm (3.6 x5.9 x 1.6")	6.9 x 10.4 x 3.4 cm (2.72" x 4.1" x 1.35')	6.9 x 10.4 x 3.4 cm (2.72" x 4.1" x 1.35')
<b>Weight</b>	280g (10oz)	280g (10oz)	196g (7oz)	196g (7oz)
<b>Compensation</b>	Temperature	Temperature	Temperature	Temperature
<b>Alarms</b>	none	User configurable Hi & Low alarms	none	none
<b>LED Indicators</b>	none	alarm status	none	none
<b>Storage Temperature</b>	0 degrees -45 degrees C (32 degrees - 113 degrees F - 20degrees - 60 degrees (-4 degrees - 140 degrees F) on intermittent basis	0 degrees -45 degrees C (32 degrees - 113 degrees F - 20degrees - 60 degrees (-4 degrees - 140 degrees F) on intermittent basis	0 degrees -45 degrees C (32 degrees - 113 degrees F - 20degrees - 60 degrees (-4 degrees - 140 degrees F) on intermittent basis	0 degrees -45 degrees C (32 degrees - 113 degrees F - 20degrees - 60 degrees (-4 degrees - 140 degrees F) on intermittent basis
<b>Operating Temperature</b>	5 degrees - 45 degrees C (41 degrees - 113 degrees F)	5 degrees - 45 degrees C (41 degrees - 113 degrees F)	5 degrees - 45 degrees C (41 degrees - 113 degrees F)	5 degrees - 45 degrees C (41 degrees - 113 degrees F)
<b>Humidity</b>	Non-condensing 0-95% RH	Non-condensing 0-95% RH	Non-condensing 0-95% RH	Non-condensing 0-95% RH
<b>Power</b>	2 AA Alkaline batteries; 1,200 hours continuous use	2 AA Alkaline batteries; 1,200 hours continuous use	2 AA Alkaline batteries; 1,300 hours continuous use	2 AA Alkaline batteries; 1,300 hours continuous use

# COMPREHENSIVE EASY-TO-USE PATIENT SIMULATORS

47

Patient Simulator Series



Compatible with  
**myBC mobile**

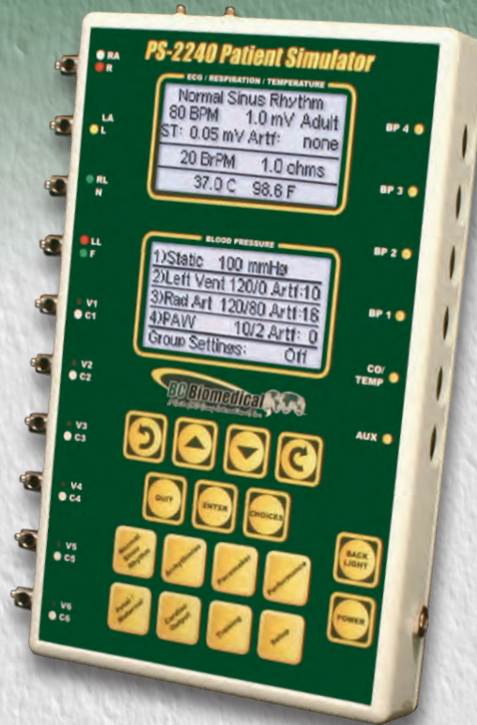

## PS-2240

PICTURED



## PS-2200 SERIES

The PS-2200 Multi-Parameter Patient Simulator Series are the most comprehensive, easy-to-use simulators on the market. These new portable simulators are intuitive to use since there are NO MORE CODES to enter.

Each model provides ECG, blood pressure, respiration and temperature simulation. Models are available with one, two or four independent blood pressure outputs. All models will support the fetal/maternal, SpO<sub>2</sub>, cardiac output and PSR-2200 remote options.

The PS-2200 Series makes viewing and selecting the desired waveforms and parameters quick and intuitive. All operational information is available at the same time on two cursor-based graphic displays, allowing for easy maneuvering through parameters and scrolling through available options.

**NEW**



\*Previously purchased PS-2000 Series now upgradable to Bluetooth® wireless technology using BC20-41402 adapter. Call our sales department to request upgrade.



ECG NSR	
Rate	30, 40, 45, 60, 80, 90, 100, 120, 140, 160, 180, 200, 220, 240, 260, 280, 300 BPM
Accuracy	± 1%
Amplitude	.05, .10, .15, .20, .25, .30, .35, .40, .45, .50, 1.0, 1.5, 2.0, 2.5, 3.0, 3.5, 4.0, 4.5, 5.0 mV
Accuracy	± 2% @ Lead II
High Level	200 times Amplitude
Accuracy	± 5%
QRS Interval	Adult (80ms), Pediatric (40ms)
ST Segment (Elevation)	± 0, .05, .1, .2, .3, .4, .5, .6, .7, .8 mV
ECG Performance	
Sine Wave	0.1, 0.5, 5, 10, 40, 50, 60, 100 Hz
Square Wave	0.125, 2.000 Hz
Triangle Wave	2.000, 2.500 Hz
Pulse Wave	30, 60, 120 BPM; 60 ms
Amplitude	.05, .10, .15, .20, .25, .30, .35, .40, .45, .50, 1.0, 1.5, 2.0, 2.5, 3.0, 3.5, 4.0, 4.5, 5.0 mV
R-Wave (Havertriangle)	
Rate	30, 60, 80, 120, 200, 250 BPM
Width	8, 10, 12, 20, 30, 40, 50, 60, 70, 80, 90, 100, 120, 130, 140, 150, 160, 170, 180, 190, 200 ms
Amplitude	.05, .10, .15, .20, .25, .30, .35, .40, .45, .50, 1.0, 1.5, 2.0, 2.5, 3.0, 3.5, 4.0, 4.5, 5.0 mV
Rate Accuracy	± 1%
Amplitude Accuracy	± 2% @ Lead II
R-Wave <= 20 ms	± 5% @ Lead II
Blood Pressure	
Channels	1 – PS-2210 2 – PS-2220 4 – PS-2240
Static Pressure	-10, -5, 0, 20, 40, 50, 60, 80, 100, 150, 160, 200, 240, 250, 300, 320, 400 mmHg
Accuracy	± (2% of Reading + 2 mmHg)
Impedance	300 Ohms
Accuracy	± 10%
Excitation Range	2 to 16 V RMS
Excitation Frequency	DC to 5 KHz
Sensitivity	5 or 40 µV/V/mmHg
Respiration Artifact	0 to 16 mmHg
Remote(Optional)	
Fully compatible with PSR-2200	

Pacemaker Waveforms	
Amplitude	1, 2, 3, 4, 5, 6, 7, 8, 9, 10 mV
Accuracy	± 10%
Width	0.1, 0.5, 1.0, 1.5, 2.0 ms
Accuracy	± 5%
Rate	75 BPM
Accuracy	±1%
Respiration	
Rate	Apnea, 15, 20, 30, 40, 60, 80, 100, 120 BrPM
Accuracy	± 1%
Impedance delta	0.1, 0.2, 0.5, 1.0, 2.0, 3.0 Ω
Accuracy	± 10% + 0.05 Ω
Baseline	500, 1000, 1500, 2000 Ω
Accuracy	± 5%
Lead	LA or LL
Temperature	
Temperature	0, 24, 30, 37, 40 °C (32.0, 75.2, 86.0, 98.6, 104.0 °F)
Accuracy	± 0.1 °C
Type	YSI Series 400 and 700
Fetal / Maternal	
Fetal Heart Rate	60, 90, 120, 140, 150, 210, 240 BPM
Inter Uterine Pressure Response Types	Uniform Deceleration Early Deceleration Late Deceleration Uniform Acceleration
IUP Wave	Bell Curve with 90 mmHg Peak and 90 Sec Width
IUP Trigger	Manual Auto: 2,3,5 Minute
Cardiac Output	
Injectate Volume	10 cc
Injectate Temperature	0 °C or 24 °C , ± 2%
Calibration Coefficient	0.542 (0 °C Inj), 0.595 (24 °C Inj)
Blood Temperature	37 °C (98.6 °F), ± 2%
Cardiac Output	2.5, 5.0, 10.0 l/min, ± 5%
Simulations	Normal Flow Faulty Injectate Left-to-Right Shunt Temperature Calibration Pulse
Temperature Calibration Pulse	1.5 °C Down for 1 sec, ± 1%
Catheter Type	Baxter Edwards, 93a-131-7f
SpO <sub>2</sub> Simulation (MSP-2100 & Finger SIM™ Req'd. or FSX 1101)	
Rate	30 to 300 BPM
SpO <sub>2</sub> Output	80, 90 & 97%

# COST EFFECTIVE PATIENT SIMULATORS

49

Patient Simulator Series



Compatible with  
**myBC mobile**



**PS-2110**  
PICTURED



## PS-2100 SERIES

The PS-2100 Patient Simulator Series offers cost effective simulation with many features. The PS-2105 offers ECG simulation, 36 arrhythmias, 17 waveforms with constant QRS duration, 15 machine performance-testing waveforms with 7 paced rhythms, plus a unique training mode with an optional SpO2 output.

If you want basic multi-parameter simulation, the PS-2110 is the right choice. It provides ECG, blood pressure, respiration and temperature simulation, plus limited fetal/maternal simulation.

The PS-2100 Series makes viewing, selecting the desired waveforms, and parameters quick & intuitive, with all operational information being available at the same time on the cursor-based graphic display, allowing for easy maneuvering through parameters and scrolling through available options.

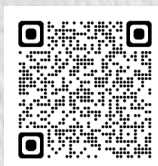

\*Previously purchased PS-2000 Series now upgradable to Bluetooth using BC20-41402 adapter. Call our sales department to request upgrade.

# SPECIFICATIONS

## PS-2105

ECG Functions	
Rate	30 to 300 BPM
Amplitude	0.05 to 5mV
S-T Segment Elevation	± 0.05 to 0.8 mV
Artifacts	50 Hz, 60 Hz, Muscle, Baseline Wander, Respiration
QRS Interval	Adult (80 ms) or Pediatric (40 ms)
Arrhythmia Functions	
Arrhythmias	49 different
General Groups	Supraventricular, Premature, Ventricular, Conduction
Triggering	Manual & Automatic
Pacemaker Functions	
Waveforms	Atrial, Pacer, Asynchronous, Non-Capture, Non-Function, Demand - Occasional, Demand - Frequent, AV - Sequential
Pulse Height	1 to 10 mV
Pulse Width	0.1 to 2 ms
ECG-Performance Functions	
Sine Waves	0.1 to 100 Hz
Square Waves	0.125, 2 Hz
Triangle Waves	5, 2.5 Hz
Pulse Waves	30, 60, 120 BPM; 60 ms Width
Amplitude	0.05 to 5 mV (Lead II)
Automatic Mode	Yes
R Wave Rate	30, 60, 80, 120, 200, 250 BPM
R Wave Width	8 to 200 ms
R Wave Amplitude	0.05 to 5 mV (Lead II)
Training	
Timer	Manual, 10, 15, 20, 25, 30 s
Randomizer	Off, On
Arrhythmias	All, Subset
SpO <sub>2</sub> Simulation (MSP-2100 & FingerSim™ Req'd.)	
Rate	30 to 300 BPM
SpO <sub>2</sub> Output	80, 90 & 97%

## PS-2110

ECG Functions	
Rate	30,60,80,120,180,240,300 BPM
Accuracy	± 1%
Amplitude	0.5, 1.0, 1.5, 2.0 mV
Accuracy	± 2% @ Lead II
High Level	200 times Amplitude
ECG Performance	
Sine Wave	0.1,0.5,5,10,40,50,60,100 Hz
Square Wave	0.125, 2.000 Hz
Triangle Wave	2.000 Hz
Rate Accuracy	± 1%
Amplitude Accuracy	± 2% @ Lead II
Blood Pressure	
Static Pressure	0,20,40,80,100,200,250,300 mmHg
Accuracy	± (2% of Reading + 2 mmHg)
Impedance	300 Ω
Accuracy	± 10%
Excitation Range	2 to 16 V RMS
Excitation Frequency	DC to 5 kHz
Sensitivity	5 or 40 μV/mmHg
Respiration	
Rate	Apnea,15,20,30,40,60,80,100, 120 BrPM
Accuracy	± 1%
Impedance delta	0.1,0.2,0.5,1.0,2.0,3.0 Ω
Accuracy	± 10% + 0.05 Ω
Baseline	500,1000 Ω
Accuracy	± 5%
Lead	LA or LL
Temperature	
Temperature	30,37,40 °C (86.0,98.6,104.0 °F)
Accuracy	± 0.1 °C (± 0.1 °F)
Type	YSI Series 400 and 700
SpO <sub>2</sub> Simulation (MSP-2100 & FingerSim™ Req'd. or FSX 1101)	
Rate	30 to 300 BPM
SpO <sub>2</sub> Output	80, 90 & 97%

## COMPACT & LIGHTWEIGHT PATIENT SIMULATORS



**PS-2010**  
PICTURED

CE

## PS-2000 SERIES

The PS 2000 Series are compact lightweight patient simulators with a lot of processing power in a small package.

The PS-2010 is the perfect tool for providing a 10 lead wire hook up for those diagnostic 12 lead ECG machines. This small, lightweight, feature packed simulator is a must for your test equipment tool box.

The PS-2006 is unique in the market place. Many of the new monitors now being released have a six lead configuration. By popular demand, the PS-2006, six lead ECG/PVC simulator was developed. Press a button and insert PVCs into the ECG trace.

The PS-2005 is a small unit for those who need five lead ECG simulation only and are looking for a cost effective simulator. Need to check your lead wires? There is a built-in lead wire tester for your convenience.



# COMPARISON CHART

Models	PS-2005	PS-2006	PS-2010	PS-2105	PS-2110	PS-2200
General						
Display	11 LED	11 LED	11 LED	1 LCD Graphical 128x64 pixels	1 LCD Graphical 128x64 pixels	2 LCD Graphical 128x64 pixels
Backlight	No	No	No	Yes	Yes	Yes
Lead Test Terminals	Yes	No	Yes	No	Yes	Yes
RS-232	No	No	No	Yes	Yes	Yes
Power	(1) 9 Volt Battery	(1) 9 Volt Battery	(1) 9 Volt Battery	(2) 9 Volt Batteries	(2) 9 Volt Batteries	(2) 9 Volt Batteries
Battery Eliminator	No	No	Yes	Yes	Yes	Yes

ECG-NSR	Yes	Yes	Yes	Yes	Yes	Yes
Leads	5	6	10	10	10	10
Rates	4	4	4	17	7	17
Amplitudes	1	1	1	4	4	19
QRS Interval	Adult	Adult	Adult	Adult & Pediatric	Adult	Adult & Pediatric
ST Segment Elevation	No	No	No	19	No	19

ECG-Performance	Yes	Yes	Yes	Yes	Yes	Yes
Sine Waves	3	3	3	8	8	8
Square Waves	2	2	2	2	2	2
Triangle Waves	1	1	1	2	1	2
Pulse Waves	--	--	--	3	--	3

Respiration	No	No	No	No	Yes	Yes
Rate	--	--	--	--	8	8
Baseline	--	--	--	--	2	4
Delta Impedance	--	--	--	--	6	6

Pacemaker	No	No	No	Yes	No	No
Arrhythmias	No	PVC on Demand	No	49	12	49
Blood Pressure	No	No	No	No	1 Channel	1, 2, or 4 Channel
Temperature	No	No	No	No	YSI 400/700	YSI 400/700

Special Modes						
SpO <sub>2</sub> Simulation	No	No	No	w/MSP-2100 or FSX-1101	w/MSP-2100 or FSX-1101	w/MSP-2100 or FSX-1101
Fetal/Maternal	No	No	No	No	Yes	Optional
Cardiac Output	No	No	No	No	No	Optional
Training Mode	No	No	No	Yes	No	Yes
Lead Test	Yes	No	Yes	No	Yes	Yes

Physical	ABS Plastic Case	ABS Plastic Case	ABS Plastic Case	ABS Plastic Case	ABS Plastic Case	ABS Plastic Case
Size	5.12" x 2.56" x .97"	5.15" x 2.89" x 1.06"	7.26" x 4.46" x 1.51"	8.63" x 5.5" x 1.63"	8.63" x 5.5" x 1.63"	8.63" x 5.5" x 1.63"
Weight	< 1 Lbs	≤ 0.5 Lbs (0.23 kg)	< 1 Lbs	< 2 Lbs	< 2 Lbs	< 2 Lbs

## HIGH PRECISION DIGITAL PRESSURE METERS



### DPM-2350

PICTURED



## DPM-2300 SERIES

The DPM-2300 Series is a microprocessor-based, high precision, high resolution digital pressure meter family. These meters measure both gas and liquid pressures and provide multiple engineering unit displays for the results. The unit may have one or two pressure sensors and an optional temperature sensor input to measure pressure and temperature all in one meter.

There are five standard pressure ranges. Models are available with any combination of ranges. The DPM-2350 subset provides a differential pressure option using a single sensor in any of the five ranges. Optional features allow the addition of RS-232 communication, temperature measurement and DC analog outputs.



- ◆ Large graphics display with cursor selection of options and setup
- ◆ High resolution 24 bit measurement
- ◆  $\pm 0.05\%$  FS pressure accuracy
- ◆ Standard pressure scales include 13 different engineering unit ranges  
  
(PSI, mmHg@0 °C, mmHg@20 °C, inHg@0 °C, inHg@20 °C, cmH<sub>2</sub>O@20 °C, inH<sub>2</sub>O@4 °C, inH<sub>2</sub>O@20 °C, inH<sub>2</sub>O@60 °F, kg/cm<sup>2</sup>, kPa, mBar, Bar)
- ◆ MAX And MIN pressure value capture and storage
- ◆ Digital calibration
- ◆ Selectable display options & digit sizes
- ◆ Battery life display (0 to 100%)
- ◆ Programmable digital averaging filter
- ◆ Display contrast is software adjustable
- ◆ Digital zero adjustment
- ◆ Made in USA

**DPM-2302 Adds:**

- ◆ RS-232 serial communications

**Second Pressure Sensor Adds:**

- ◆ Independent pressure channel
- ◆ Separate and combined display option

**Temperature Option Adds:**

- ◆ YSI 700 or 100  $\Omega$  RTD temperature probe interface
- ◆ -20.0 to 100.0 °C (-4.0 to 212.0 °F) range
- ◆  $\pm 0.5\%$  FS accuracy

**Analog Output Option Adds:**

- ◆ DC output proportional to the displayed pressure or temperature
- ◆  $\pm 0.1\%$  FS output accuracy

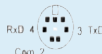
PRESSURE MEASUREMENT (GAUGE)		
RANGE	100 PSI SENSOR	-13.5 to 100.0 PSI
	75 PSI SENSOR	-13.5 to 75.0 PSI
	10 PSI SENSOR	-10.0 to 10.0 PSI
	5 PSI SENSOR	-5.0 to 5.0 PSI
	0.3 PSI SENSOR	-0.3 to 0.3 PSI
RESOLUTION	100 PSI SENSOR	0.001 PSI
	75 PSI SENSOR	0.001 PSI
	10 PSI SENSOR	0.0001 PSI
	5 PSI SENSOR	0.0001 PSI
	0.3 PSI SENSOR	0.00001 PSI
MAXIMUM OVERPRESSURE	100 PSI SENSOR	200 PSI
	75 PSI SENSOR	200 PSI
	10 PSI SENSOR	45 PSI
	5 PSI SENSOR	15 PSI
	0.3 PSI SENSOR	5 PSI
ACCURACY	$\pm 0.05\%$ FS	
DIGITAL FILTER	0 to 10 seconds, Selectable	
COMPATIBLE MEDIA	Only non-corrosive, non-ionic, or otherwise pure fluids and/or gases that are compatible with sensor materials including glass, silicon, ceramic, epoxy, RTV, gold, aluminum and nickel.	
CONNECTIONS	See Model Number Breakdown	
PHYSICAL & ENVIRONMENTAL		
DISPLAY	128 X 64 Pixels Non-Backlit Graphical LCD	
CONSTRUCTION	ENCLOSURE	ABS Plastic
	OVERLAY	Back-printed Lexan
SIZE	7.69 x 3.97 x 1.80 Inches (195.3 x 100.8 x 45.7 mm)	
WEIGHT	< 1 Lbs (0.45 kg)	
OPERATING RANGE	15 to 30 °C (59 to 86 °F)	
STORAGE RANGE	-40 to 60 °C (-40 to 140 °F)	
ELECTRICAL & MISC.		
BATTERY	9V Alkaline Battery (ANSI/NEDA 1604A or equivalent)	
BATTERY ELIMINATOR	9 VDC, 200 mA	
	 BC20-21110 BATTERY ELIMINATOR ( UNIVERSAL )	
POWER CONSUMPTION	ON	< 35 mA
	OFF	< 40 $\mu$ A
BATTERY LIFE	CONTINUOUS	80 hours
	OFF	1 year
RS-232 COMMUNICATIONS	BAUD	115200
	DATA BITS	8
	START BITS	1
	STOP BITS	1
	PARITY	None
	HANDSHAKING	None
	CONNECTIONS	Seven (7) pin Mini-DIN Receptacle Pinout: RS-232  NOTE: As Viewed from Unit Exterior

## HIGH PRECISION DIGITAL PRESSURE METERS

55

Pressure Meter Series



**DPM-2250**  
PICTURED



## DPM-2200 SERIES

The DPM-2200 Series is a microprocessor- based, high precision, digital pressure meter family. They measure both gas and liquid pressures and provide multiple engineering unit displays for the results. The unit may have one or two pressure sensors and an optional temperature sensor input to measure pressure and temperature all in one meter. Also standard & high frequency analog outputs options are available.

There are five standard pressure ranges. Models are available with any combination of ranges. The DPM-2250 Subset provides a differential pressure option using a single sensor in any of the five ranges. Optional features allow the addition of RS-232 communication, Temperature measurement and a standard or high frequency analog output.





- ◆ Single or dual pressure sensors
  - ◆ Large graphics display with cursor selection of options & parameters
  - ◆ ± 0.05% FS pressure accuracy
  - ◆ 16 bit measurement
  - ◆ Standard pressure scales include 13 different engineering unit ranges
- (PSI, mmHg@0 °C, mmHg@20 °C, inHg@0 °C, inHg@20 °C, cmH<sub>2</sub>O@20 °C, inH<sub>2</sub>O@4 °C, inH<sub>2</sub>O@20 °C, inH<sub>2</sub>O@60 °F, kg/cm<sup>2</sup>, kPa, mBar, Bar)

- ◆ Digital calibration & zero adjust
- ◆ Selectable display options & digit sizes
- ◆ Battery life display (0 to 100%)
- ◆ Programmable digital filter
- ◆ Software adjustable display contrast
- ◆ Flash programmable, upgradeable
- ◆ Optional DC or high frequency (up to 100 Hz Cycle Rate) outputs
- ◆ Pressure & vacuum
- ◆ Liquids & gases

**DPM-2202 Adds:**

- ◆ Min/Max pressure value capture and storage
- ◆ RS-232 serial communications

**Second Pressure Sensor Adds:**

- ◆ Independent pressure channel
- ◆ Separate & combined display option

**Temperature Option Adds:**

- ◆ YSI 700 or 100 Ω RTD temperature probe interface
- ◆ -20.0 to 100.0 °C (-4.0 to 212.0 °F)
- ◆ ± 0.5% FS accuracy

**Analog Output Option Adds:**

- ◆ Standard or high frequency output
- ◆ DC output proportional to the displayed pressure or temperature
- ◆ ± 0.1% FS output accuracy

PRESSURE MEASUREMENT (GAUGE)		
RANGE	100 PSI SENSOR	-13.5 to 100.0 PSI
	75 PSI SENSOR	-13.5 to 75.0 PSI
	10 PSI SENSOR	-10.0 to 10.0 PSI
	5 PSI SENSOR	-5.0 to 5.0 PSI
	0.3 PSI SENSOR	-0.3 to 0.3 PSI
RESOLUTION	100 PSI SENSOR	0.01 PSI
	75 PSI SENSOR	0.01 PSI
	10 PSI SENSOR	0.001 PSI
	5 PSI SENSOR	0.001 PSI
	0.3 PSI SENSOR	0.0001 PSI
ACCURACY	± 0.05% FS	
DIGITAL FILTER	0 to 10 seconds, Selectable	
COMPATIBLE MEDIA	Only non-corrosive, non-ionic, or otherwise pure fluids and/or gases that are compatible with sensor materials including glass, silicon, ceramic, epoxy, RTV, gold, aluminum and nickel.	
CONNECTIONS	Male Luer Coupler	

PHYSICAL & ENVIRONMENTAL		
DISPLAY	128 X 64 Pixels Non-Backlit Graphical LCD	
CONSTRUCTION	ENCLOSURE	ABS Plastic
	OVERLAY	Back-printed Lexan
SIZE	7.69 x 3.97 x 1.80 Inches (195.3 x 100.8 x 45.7 mm)	
WEIGHT	< 1 lbs (0.45 kg)	
OPERATING RANGE	15 to 30 °C (59 to 86 °F)	
STORAGE RANGE	-40 to 60 °C (-40 to 140 °F)	

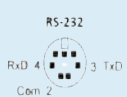
ELECTRICAL & MISC.		
BATTERY	9V Alkaline Battery (ANSI/NEDA 1604A or equivalent)	
BATTERY ELIMINATOR	9 VDC, 200 mA 	
	BC20-21110 BATTERY ELIMINATOR ( UNIVERSAL)	
POWER CONSUMPTION	ON	< 35 mA
	OFF	< 40 µA
BATTERY LIFE	CONTINUOUS	80 hours
	OFF	1 year
RS-232 COMMUNICATIONS	BAUD	115200
	DATA BITS	8
	START BITS	1
	STOP BITS	1
	PARITY	None
	HANDSHAKING	None
	CONNECTIONS	Seven (7) pin Mini-DIN Receptacle Pinout:  NOTE: As Viewed from Unit Exterior

# HIGH PRECISION DIGITAL PRESSURE METERS

57

Pressure Meter Series



## DPM-2001 PLUS

PICTURED



## DPM-2000 SERIES

The DPM-2000 Series is a microprocessor- based family of meters that offers not only positive and negative pressure sensing of compatible liquids and gases, but also has models with temperature and RS-232.

The DPM-2001 is the base model. The DPM-2001PLUS adds a “min/max” feature plus a RS-232 port. The top-of-the-line DPM-2100 is a pressure/ temperature meter. It has all the features of the PLUS model and also includes a YSI 700 temperature probe interface.

Each model has a battery life display (0 to 100%), software adjustable LCD contrast, digital calibration (no pots to turn), 0.1% of full scale accuracy, -13.50 to 100.00 PSI range, digital zero adjust and four pressure scales: PSI, inH<sub>2</sub>O, cmH<sub>2</sub>O and mmHg.



- ◆ Pressure ranges:
  - **13.50 to 100.00 PSI**
  - **701 to 5190 mmHg @ 20 °C**
  - **951 to 7043 cmH<sub>2</sub>O @ 20 °C**
  - **374 to 2773 inH<sub>2</sub>O @ 20 °C**
- ◆ ± 0.1% FS pressure accuracy
- ◆ 5 digit LCD display
- ◆ Programmable digital filter
- ◆ Digital calibration & zero adjust
- ◆ Male Luer connector
- ◆ Battery life display (0 to 100%)
- ◆ Liquids & gases
- ◆ Made in USA

**DPM-2001PLUS Adds:**

- ◆ Min/max value capture
- ◆ RS-232 serial communications

**DPM-2100 Adds:**

- ◆ YSI 700 temperature probe interface
- ◆ 0.0 to 100.0 °C (32.0 to 212.0 °F)
- ◆ ± 0.5% FS accuracy

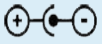
PRESSURE	
RANGE	-13.50 to 100.00 PSI -701 to 5190 mmHg @ 20 °C -374 to 2773 inH <sub>2</sub> O @ 20 °C -951 to 7043 cmH <sub>2</sub> O @ 20 °C
RESOLUTION	0.01 PSI 1 mmHg @ 20 °C 1 inH <sub>2</sub> O @ 20 °C 1 cmH <sub>2</sub> O @ 20 °C
MAXIMUM OVERPRESSURE	200 PSI
ACCURACY	± 0.1% FS
DIGITAL FILTER	1 – 255 samples
COMPATIBLE MEDIA	Only non-corrosive, non-ionic, or otherwise pure fluids and/or gases that are compatible with sensor materials including glass, silicon, ceramic, epoxy, RTV, gold, aluminum and nickel.
CONNECTIONS	Male Luer Coupler
PHYSICAL & ENVIRONMENTAL	
DISPLAY	5 Digit, 7-Segment Non-Backlit LCD
CONSTRUCTION	ENCLOSURE      ABS Plastic
	OVERLAY            Lexan, Back Printed
MEMORY	SETUP              EEPROM, All Parameters
	RETENTION        10 Years w/o Power
SIZE	7.69 x 3.97 x 1.82 Inches (195.3 x 100.8 x 46.2 mm)
WEIGHT	≤ 1 Lbs (0.45 kg)
OPERATING RANGE	0 to 50 °C (32 to 122 °F)
STORAGE RANGE	-40 to 60 °C (-40 to 140 °F)
ELECTRICAL & MISC.	
BATTERY	9V Alkaline Battery (ANSI/NEDA 1604A or equivalent)
BATTERY ELIMINATOR	9 VDC, 200 mA  BC20-21110 BATTERY ELIMINATOR (UNIVERSAL)
POWER CONSUMPTION	ON                    < 15 mA
	OFF                  < 40 µA
BATTERY LIFE	CONTINUOUS      80 hours
	OFF                  1 year
RS-232 COMMUNICATIONS	BAUD                115200
	DATA BITS         8
	START BITS        1
	STOP BITS         1
	PARITY             None
	HANDSHAKING    None
CONNECTIONS	1/8 Stereo Receptacle for use with BC20-21102 RS-232 Cable

## SMALL & POWERFUL DIGITAL SpO2 SIMULATION

59

Pulse Oximetry Simulator

LIFETIME  
Warranty\*



CE

# FSX-1101

The FSX-1101 is a digital SpO2 simulator with many features, including a LIFETIME warranty\*. It is small and light weight, yet very powerful. It has a bright, 2.4" color touchscreen that, coupled with an intuitive menu structure, allows easy access and viewing of all setup and function parameters.

To make testing your SpO2 monitor easier and faster, the FSX-1101 has a set of factory presets. Need to do a more specific evaluation? There is a Manual Mode that allows individual control over each parameter only limited by the specific values that are available.

The FSX-1101 is at the top of its class in performance and specifications. SPO2 (in %) is selectable from six values with 2% accuracy. Heart rate (in BPM) is selectable from 10 values with 1% accuracy. Three perfusion index values are also available.

The FSX-1101 can be connected to your BC Biomedical NIBP-1000 Series, PS-2100 Series or PS-2200 Series patient simulator via the auxiliary port (by using the provided cable). This allows for a synchronized SPO2 and ECG simulation for your monitors.



\*LIFETIME Limited Warranty requires product registration and return to factory for annual calibration

# FEATURES & SPECIFICATIONS

<ul style="list-style-type: none"> <li>◆ Small, handheld, lightweight, rugged</li> <li>◆ Intuitive user interface</li> <li>◆ Color touch screen</li> <li>◆ Preset &amp; manual mode operation</li> <li>◆ 6 saturation levels from 80-99%</li> <li>◆ Heart rates from 30-245 BPM</li> <li>◆ Adjustable perfusion index</li> <li>◆ Pulse synchronized with NIBP-1000, PS-2100 or PS-2200 Series</li> <li>◆ LIFETIME Warranty*</li> <li>◆ Powered by two AA batteries or the connected BC Biomedical device</li> <li>◆ Made in USA</li> </ul>		FSX-1101 Specifications
	SpO2	80, 85, 90, 95, 98, 99%
	SpO2 Accuracy	2%
	Heart Rate	30, 40, 60, 80, 100, 120, 140, 150 & 245 BPM
	Rate Accuracy	1%
	PI	0.2%, 2.0% & 10%
	Manufacturer Type	Nellcor, Masimo, Nonin, Nihon Kohden, Mindray, GE-Ohmeda, Philips/HP and BCI
	Tests	Manual plus Factory Preset (5 steps)
	Battery Type	2xAA Alkaline Batteries
	Battery Life	10 Hours (Full Backlight)
	Display	Color Touchscreen, 2.4 inch
	Size	2.5 x 3.75 x 1 (inches)(without finger)
	Weight	6 oz (with batteries)

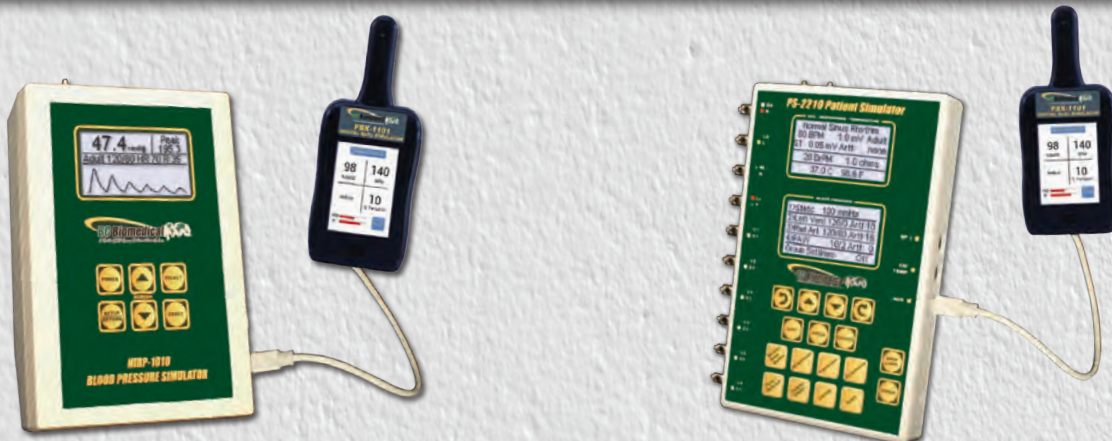

PULSE SYNCHRONIZED WITH NIBP-1000 SERIES, PS-2100 & PS-2200 SERIES

← For product pricing- please see page 140 →

Pulse Oximetry Simulator



# FINGERSIMS™



# MSP-2100

(FingerSim™ Not Included)

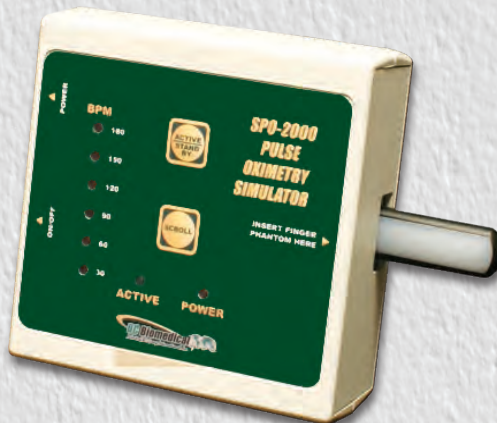

# SPO-2000

(FingerSim™ Not Included)



## **Features - FingerSims™**

- ◆ Easy-to-use SpO2 simulator
- ◆ Quick testing of pulse oximetry systems including sensors
- ◆ 80%, 90% & 97% saturation levels
- ◆ Inexpensive & accurate
- ◆ Made in USA

## **Features - MSP-2100**

- ◆ Accepts the FingerSims™ to provide SpO2 outputs
- ◆ Pulse synchronized with PS-2100, PS-2200 & NIBP-1000 Series products via AUX port
- ◆ Powered via AUX port
- ◆ Made in USA

## **Features - SPO-2000**

- ◆ Accepts the FingerSims™ to provide SpO2 outputs
- ◆ 30, 60, 90, 120, 150 & 180 BPM pulse rates
- ◆ External AC adapter
- ◆ Compact & cost-effective
- ◆ Maintenance-free
- ◆ Made in USA

## FINGERSIMS™ SPECIFICATIONS

Saturation nominal values 80%, 90% & 97%.  
*These are the nominal Red-to-Infrared Ratios (AC) @ 72.5 F & 660 nM/910 nM*

Light Absorption	Infrared: 10 to 40 dB Red: 15 to 40 dB
Typical Infrared Percent Modulation when Squeezed	0 to 5%
Long Term Storage Temp Range	32 to 104 °F (0 to 40 °C)
Operating Temp.	65 to 90 °F (18 to 32 °C)

## MSP-2100 SPECIFICATIONS

Accuracy	±1 BPM
Power	AUX Port
Weight	≤ 1 Lbs (0.45 kg)
Size	2.3 x 3.6 x 1.5 In (58.4 x 91.4 x 38.1 mm)

## SPO-2000 SPECIFICATIONS

Accuracy(Rate)	± 1%
Power	AC Adapter
Weight	≤ 1 Lbs (0.45 kg)
Size	5.2 x 5.2 x 2.5 Inches (132.1 x 132.1 x 63.5 mm)

**NEW****SAFETY ANALYZER WITH AUTO SEQUENCES & BUILT-IN BLUETOOTH WIRELESS TECHNOLOGY!**

Safety Analyzer Series



Compatible with  
**myBC mobile**



 **Bluetooth®**

**SA-2600**

The SA-2600 is the newest addition to our already popular Safety Analyzer 2000 Series. It is the easiest to use safety analyzer with a full touch screen.

It has fully customizable autosequences which allow you to run through a full set of tests on a device with limited user intervention. The autosequences have adjustable test limits and can export pass/fail results.

The SA-2600 is **Bluetooth®** capable to allow for connection to our myBC mobile app. Through our app you can create and control more auto sequences and have the results exported to your phone.





# FEATURES

64

Safety Analyzer Series

- ◆ Custom and fixed autosequences
- ◆ Micro USB and **Bluetooth®** communications
- ◆ Small, lightweight portable analyzer
- ◆ Line voltage measurement
- ◆ Device under test current measurement
- ◆ 200mA earth/ground lead resistance
- ◆ Point-to-point testing
- ◆ Enclosure/chassis leakage current
- ◆ External resistance
- ◆ External leakage current
- ◆ Source receptacle wiring integrity monitor
- ◆ MAP (isolation) function
- ◆ Internal ECG simulator
- ◆ True RMS readings
- ◆ AAMI ES1-1993 or IEC 60601 selectable test loads
- ◆ 90 to 264 VAC operation
- ◆ Touch controls keys – no knobs
- ◆ LED status indicators
- ◆ Audible feedback
- ◆ Self-test points
- ◆ Externally replaceable ground fuse
- ◆ 4.3” color touchscreen
- ◆ Made in USA

← For product pricing- please see page 154 →

# SAFETY ANALYZERS TO MEET YOUR NEEDS

65

Safety Analyzer Series



## SA-2010S

PICTURED

## SA-2000 SERIES

The Model SA-2010S series is a microprocessor based electrical safety analyzer with a built-in patient simulator. It allows for a multitude of tests to be performed on a device using the same unit and lead connections.

It provides a full electrical safety analyzer, as well as, ECG simulation with four waveforms with constant QRS duration and six machine performance testing waveforms. There is patient lead testing for 10 inputs.

The SA-2000 Series is a microprocessor-based electrical safety analyzer family. There are six models that provide everything from basic testing functions to the most complete set of features of any handheld unit on the market.



# COMPARISON CHART



Safety Analyzer Series

Models	SA-2000	SA-2001	SA-2005	SA-2010	SA-2010S	SA-2600
<b>Voltage (Rating)</b>	90 to 264 VAC	90 to 264 VAC	90 to 264 VAC	90 to 264 VAC	90 to 264 VAC	90 to 264 VAC
<b>Current (Rating)</b>	20 A	20 A	20 A	20 A	20 A	20 A
<b>RS-232</b>	On “-R	On “-R	On “-R	On “-R	On “-R	Micro USB
<b>Measures:</b>						
<b>Voltage (VAC)</b>	No	90 to 264 (± 3% R)	90 to 264 (±3% R)	90 to 264 (±3% R)	90 to 264 (±3% R)	90 to 264 (±3% R)
<b>Current (A)</b>	No	0 to 19.99 (± 5% R)	0 to 19.99 (± 5% R)	0 to 19.99 (± 5% R)	0 to 19.99 (± 5% R)	0 to 19.99 (± 5% R)
<b>Leakage Current (µA)</b>	0 to 1999	0 to 1999	0 to 1999	0 to 1999	0 to 1999	0 to 1999
	DC 25 Hz to 1 kHz (± 1% R)	DC 25 Hz to 1 kHz (± 1% R)	DC 25 Hz to 1 kHz (± 1% R)	DC 25 Hz to 1 kHz (± 1% R)	DC 25 Hz to 1 kHz (± 1% R)	DC 25 Hz to 1 kHz (± 1% R)
	1 kHz to 100 kHz (± 2.5% R)	1 kHz to 100 kHz (± 2.5% R)	1 kHz to 100 kHz (± 2.5% R)	1 kHz to 100 kHz (± 2.5% R)	1 kHz to 100 kHz (± 2.5% R)	1 kHz to 100 kHz (± 2.5% R)
	100 kHz to 1 MHz (± 5% R)	100 kHz to 1 MHz (± 5% R)	100 kHz to 1 MHz (± 5% R)	100 kHz to 1 MHz (± 5% R)	100 kHz to 1 MHz (± 5% R)	100 kHz to 1 MHz (± 5% R)
<b>Resistance (Ω)</b>	0 to 1.99 (± 1% R)	0 to 1.99 (± 1% R)	0 to 1.99 (± 1% R)	0 to 1.99 (± 1% R)	0 to 1.99 (± 1% R)	0 to 1.99 (± 1% R)
	2 to 19.99 (± 1% R)	2 to 19.99 (± 1% R)	2 to 19.99 (± 1% R)	2 to 19.99 (± 1% R)	2 to 19.99 (± 1% R)	2 to 19.99 (± 1% R)
	10 mA	10 mA	10 mA	10 mA	10 mA	10 mA
<b>Patient Leads</b>	0	0	5	10	10	10
<b>MAP (Isolation)</b>	No	No	Yes	Yes	Yes	Yes
<b>Built-In ECG Simulator</b>	No	No	No	No	Yes	Yes
<b>AAMI &amp; IEC Loads</b>	AAMI Only	Yes	Yes	Yes	Yes	Yes
<b>Point-to-Point</b>	No	Yes	Yes	Yes	Yes	Yes
<b>Test Points</b>	No	Yes	Yes	Yes	Yes	Yes
<b>Test Capability:</b>						
<b>Open Ground</b>	Yes	Yes	Yes	Yes	Yes	Yes
<b>Reverse Polarity</b>	Yes	Yes	Yes	Yes	Yes	Yes
<b>Open Neutral</b>	Yes	Yes	Yes	Yes	Yes	Yes
<b>Open Line</b>	Yes	Yes	Yes	Yes	Yes	Yes
<b>Size</b>	8.65 x 5.73 x 1.92 Inches	8.65 x 5.73 x 1.92 Inches	8.65 x 5.73 x 1.92 Inches	8.65 x 5.73 x 1.92 Inches	8.65 x 5.73 x 1.92 Inches	8.65 x 5.73 x 1.92 Inches
<b>Weight</b>	≤ 2.5 lbs (1.14 kg)	≤ 3.0 lbs (1.36 kg)	≤ 3.0 lbs (1.36 kg)	≤ 3.0 lbs (1.36 kg)	≤ 3.5 lbs (1.59 kg)	≤ 3.5 lbs (1.59 kg)
<b>Auto-Sequences</b>	No	No	No	No	No	Yes
<b>Bluetooth</b>	No	No	No	No	No	Yes

← For product pricing- please see page 154 →



## CS-2000

The CS-2000 Series is a one amp current source for testing the ground continuity in equipment. This device facilitates testing to IEC 601 requirements, where a one Amp source current is required. This device interfaces directly with the BC Biomedical SA-2000 Series of Safety Analyzers as well as the Dale Technology® LT544D, LT544D Lite & 601/601E.

This series comes in two models, US and European plug and socket configurations.



# FEATURES & SPECIFICATIONS

## CS-2000 Features

- ◆ Two models available: CS-2000-U (US version with US plug & socket) and CS-2000-E (European version with European “Schuko” plug & socket)
- ◆ Facilitates testing to IEC 601 requirements
- ◆ Interfaces directly to BC Biomedical SA-2000 & SA-2000-INTL Series of safety analyzers (not needed for the SA-2600-US, SA-2600-INTL or SA-2600-AUS)
- ◆ Interfaces with Dale Technology® LT544D, LT544D Lite, 601 & 601E safety analyzers
- ◆ Universal power supply (90 to 264 VAC, 50/60 Hz)
- ◆ 1 Amp current source for resistance measurements

Electrical					
CURRENT SOURCE	1.00 to 1.02 A DC				
OPERATING LINE VOLTAGE	90-264 VAC, 50/60 Hz				
POWER CONSUMPTION	12 VA (12 W)				
LOAD CURRENT	This device is an accessory to a Safety Analyzer, refer to applicable Safety Analyzer User Manual for this Rating				
LINE PLUG	<table border="1" style="width: 100%;"> <tr> <td style="width: 20%;">CS-2000-U</td> <td style="text-align: center;">NEMA 5-15P</td> </tr> <tr> <td>CS-2000-E</td> <td style="text-align: center;">European CEE 7/7 “Schuko”</td> </tr> </table>	CS-2000-U	NEMA 5-15P	CS-2000-E	European CEE 7/7 “Schuko”
CS-2000-U	NEMA 5-15P				
CS-2000-E	European CEE 7/7 “Schuko”				
DUT RECEPTACLE	<table border="1" style="width: 100%;"> <tr> <td style="width: 20%;">CS-2000-U</td> <td style="text-align: center;">Hospital Grade NEMA 5-15R</td> </tr> <tr> <td>CS-2000-E</td> <td style="text-align: center;">European CEE 7/7 “Schuko”</td> </tr> </table>	CS-2000-U	Hospital Grade NEMA 5-15R	CS-2000-E	European CEE 7/7 “Schuko”
CS-2000-U	Hospital Grade NEMA 5-15R				
CS-2000-E	European CEE 7/7 “Schuko”				
CONNECTIONS	LINE PLUG 3 Pin Locking Plug for Safety Analyzer Chassis Cable Connection (See Description section for Compatible Safety Analyzers)  Detachable Kelvin Cable (BC20-20114) for DUT Ground Connection				
Physical					
SIZE	7.09 x 3.94 x 1.56 Inches (180 x 100 x 40 mm)				
ENCLOSURE	ABS Plastic Back-printed Lexan Overlay				
WEIGHT	< 1 Lbs (0.45 kg)				
OPERATING RANGE	0 to 50 °C (32 to 122 °F) 10 to 90% RH, Non-Condensing				
STORAGE RANGE	-40 to 60 °C (-40 to 140 °F)				

← For product pricing- please see page 155 →

# TACHOMETER WITH INTERCHANGEABLE ACCESSORIES

Tachometer



CE

## TC-1726C

The BC Biomedical model TC-1726C handheld digital tachometer is a dual function instrument providing contact and non-contact measurement of rotational and linear motions, with an accuracy of  $\pm 0.025\%$  of indicated reading  $\pm 1$  LSD.

The model TC-1726C comes complete with a convex tip, concave tip, 10 cm linear measuring wheel, 9V Alkaline battery and carrying case.

The compact size and light weight of the TC-1726C makes for easy, one-hand operation while the rugged, high-impact housing provides for years of dependable service.

This tachometer features 16 units of measurement, including miles per hour for treadmill calibration, where the unit measure is always displayed. Four memory saves are available: last, average, minimum and maximum.

Model number TC-1726C includes NIST calibration certificate.



## FEATURES & SPECIFICATIONS

- ◆ Contact or non-contact measurement
- ◆ Eight character display with floating decimal point
- ◆ Sixteen units of measurement
- ◆ Unit measure always displayed
- ◆ Four memories (last, maximum, minimum and average)
- ◆ Most significant display digit flashes to indicate need for battery
- ◆ The TC-1726C includes a NIST calibration certificate

Angular Velocity	< 100 Hz: $\pm(0.025\%$ reading + 1 digit) 100 to 1000 Hz: $\pm(0.05\%$ reading + 1 digit) >1000 Hz: $\pm(0.1\%$ reading + 1 digit)
Linear Measurement	$\pm 0.2\% \pm 1$ LSD
Transducer	Built-in photoelectric transducer, 12" operating distance
Display	8 character dot matrix LCD, contrast is adjustable for different viewing angles, 3/8" character height
Contact Adapter	Utilizes interchangeable accessories. Convex tip, concave tip and 10 cm linear measuring wheel included
Battery	9V Alkaline battery (ANSI/NEDA 1604A or equivalent)
Low Battery Indicator	Most significant display character flashes to indicate need for battery replacement
Memory	Last reading, maximum, minimum and average
Dimensions Unit	7.65 x 3.83 x 1.84 Inches (194.3 x 97.3 x 46.7 mm)
Case	10.53 x 7.18 x 2.39 Inches (267.5 x 182.4 x 60.7 mm)
Weight	< 2 Lbs. (0.91 kg)
Operating Temperature	0 to 50 °C (32 to 122 °F)
Storage Temperature	-20 to 70 °C (-4 to 158 °F)
Humidity	< 95% R.H. , Non-condensing

# HIGH PRECISION DIGITAL PRESSURE METERS

57

Pressure Meter Series



**DPM-2001 PLUS**  
PICTURED



## DPM-2000 SERIES

The DPM-2000 Series is a microprocessor- based family of meters that offers not only positive and negative pressure sensing of compatible liquids and gases, but also has models with temperature and RS-232.

The DPM-2001 is the base model. The DPM-2001PLUS adds a “min/max” feature plus a RS-232 port. The top-of-the-line DPM-2100 is a pressure/temperature meter. It has all the features of the PLUS model and also includes a YSI 700 temperature probe interface.

Each model has a battery life display (0 to 100%), software adjustable LCD contrast, digital calibration (no pots to turn), 0.1% of full scale accuracy, -13.50 to 100.00 PSI range, digital zero adjust and four pressure scales: PSI, inH<sub>2</sub>O, cmH<sub>2</sub>O and mmHg.





- ◆ Pressure ranges:
  - 13.50 to 100.00 PSI
  - 701 to 5190 mmHg @ 20 °C
  - 951 to 7043 cmH<sub>2</sub>O @ 20 °C
  - 374 to 2773 inH<sub>2</sub>O @ 20 °C
- ◆ ± 0.1% FS pressure accuracy
- ◆ 5 digit LCD display
- ◆ Programmable digital filter
- ◆ Digital calibration & zero adjust
- ◆ Male Luer connector
- ◆ Battery life display (0 to 100%)
- ◆ Liquids & gases
- ◆ Made in USA

**DPM-2001PLUS Adds:**











- ◆ Min/max value capture
- ◆ RS-232 serial communications

**DPM-2100 Adds:**

- ◆ YSI 700 temperature probe interface
- ◆ 0.0 to 100.0 °C (32.0 to 212.0 °F)
- ◆ ± 0.5% FS accuracy

PRESSURE		
RANGE	-13.50 to 100.00 PSI -701 to 5190 mmHg @ 20 °C -374 to 2773 inH <sub>2</sub> O @ 20 °C -951 to 7043 cmH <sub>2</sub> O @ 20 °C	
RESOLUTION	0.01 PSI 1 mmHg @ 20 °C 1 inH <sub>2</sub> O @ 20 °C 1 cmH <sub>2</sub> O @ 20 °C	
MAXIMUM OVERPRESSURE	200 PSI	
ACCURACY	± 0.1% FS	
DIGITAL FILTER	1 – 255 samples	
COMPATIBLE MEDIA	Only non-corrosive, non-ionic, or otherwise pure fluids and/or gases that are compatible with sensor materials including glass, silicon, ceramic, epoxy, RTV, gold, aluminum and nickel.	
CONNECTIONS	Male Luer Coupler	
PHYSICAL & ENVIRONMENTAL		
DISPLAY	5 Digit, 7-Segment Non-Backlit LCD	
CONSTRUCTION	ENCLOSURE	ABS Plastic
	OVERLAY	Lexan, Back Printed
MEMORY	SETUP	EEPROM, All Parameters
	RETENTION	10 Years w/o Power
SIZE	7.69 x 3.97 x 1.82 Inches (195.3 x 100.8 x 46.2 mm)	
WEIGHT	≤ 1 Lbs (0.45 kg)	
OPERATING RANGE	0 to 50 °C (32 to 122 °F)	
STORAGE RANGE	-40 to 60 °C (-40 to 140 °F)	
ELECTRICAL & MISC.		
BATTERY	9V Alkaline Battery (ANSI/NEDA 1604A or equivalent)	
BATTERY ELIMINATOR	9 VDC, 200 mA  BC20-21110 BATTERY ELIMINATOR (UNIVERSAL)	
POWER CONSUMPTION	ON	< 15 mA
	OFF	< 40 µA
BATTERY LIFE	CONTINUOUS	80 hours
	OFF	1 year
RS-232 COMMUNICATIONS	BAUD	115200
	DATA BITS	8
	START BITS	1
	STOP BITS	1
	PARITY	None
	HANDSHAKING	None
	CONNECTIONS	1/8 Stereo Receptacle for use with BC20-21102 RS-232 Cable

BC Adapter Part#	Manufacturer	Transducer Compatibility	Ultrasound Platform	Connector Key
ULT-PA-10	Siemens/Acuson	V5M (TEE), V7M (TEE), EV8-C4, etc. For Acuson Sequoia Ultrasound Systems	Acuson Sequoia Ultrasound Systems	Micro-pinless (small pcb) 
ULT-PA-11	SonoSite	ICT7-4, ITC8-5, C60, L38/10-5, TEEEx For Sonosite Titan and Micromaxx Ultrasound Systems	Sonosite Titan and Micromaxx Ultrasound Systems	Micro-pinless (small pcb) 156-pin ZIF 
ULT-PA-12	Siemens	6.5EV13, EC9-4, etc.	Call for Details	260-pin ZIF 
ULT-PA-13	Siemens/Acuson Ultrasonix	Siemens/Acuson 156-pin and V510B Transducers, and ATL UM4, UM9 and 5Mhz Bi-plane Ultrasonix C5-2	128XP	156-pin ITT Cannon ZIF 
ULT-PA-14	Philips/ATL	HP/Agilent/Philips 21311A, 21369A, 21378A, 21381A For HP Sonos 4500, 5500,7500 and Imagepoint For ATL HDI 1500,3000,3500 and 5000	HP Sonos 4500, 5500,7500, and Imagepoint; ATL HDI 1500,3000,3500, and 5000	260-pin ZIF 
ULT-PA-16	GE	GE LogiQ 3, 5, 7, 9 and GE Vivid 3, 5, 7, 6T, 9T	LOGIQ, Vivid & GE P9603AU	260-pin ZIF 
ULT-PA-17	Philips/ATL Mindray	Philips iE33 and iU22 diagnostic TEE - S7-2 (TEE), S7-3t (TEE), S3-1, C8-4v, C9-5, etc. all with bellhousing-Mindray DC8	iE33/iU22	260-pin ZIF 
ULT-PA-18	Philips/HP	HP/Agilent/Philips 21202A, 21364A, 21365A, 21366A, 21367A	Call for Details	156-pin ZIF 
ULT-PA-19	Philips Mindray Koelis SAS Samsung	Mindray M9, M7, TE7 Philips Sparq, CX50, Affiniti 50, Affiniti 70, Epiq 5, Epiq 7, all Koelis transducers, Samsung Medison HM70A	Sparq, CX50, Affiniti 50, Affinity 70, EPIQ 5, EPIQ 7, EPIQ CV Samsung Twin-Zip	260 pin micro zif 

BC Adapter Part #	Manufacturer	Transducer Compatibility	Ultrasound Platform	Connector Key
ULT-PA-20	Acuson/Toshiba	Acuson/Toshiba (for use with Acuson/Siemens XP, Aspen, Capasee, 3-Needle Guide C3 Transducers; ATL 3.5 DFT Transducers; Toshiba PSF-37HT and F Series Transducers)	Toshiba PVF Series, 2B701-753E	156-pin ZIF 
ULT-PA-21	Hitachi	HI VISION 900, 5500, 6500, 8500, EUB-2000, EUB-525, EUB-405 Plus	EUP-ES52M, EUP-Series Probes in general	260-pin ZIF 
ULT-PA-22	Ultraschallkopf - Aloka	UST-934N/9395, UST-945BP/945BP, ASU-32-3-M, ASU-32-WSJ, UST-556/5512, UST-5514DTU	SSD-620, SSD-650	260-pin ZIF 
ULT-PA-23	ALL	ALL Transducers	All Platforms	ALL Configurations
ULT-PA-24	Philips/ATL	T6210, L7-4 and similar 260-pin transducers with bellhousing	Call for Details	260-pin ZIF 
ULT-PA-25	GE	LogiqBook Probes - GE VIVID I 6T, 9T, etc.	Vivid	260 pin micro zif 
ULT-PA-26	Acuson Toshiba	PET-512MC, Artida, Aplio XG, Aplio MX, Aplio 80, Aplio 50, Aplio 300, Aplio 500, Aplio XV, Nemio XG, Viamo, Xario XG, and Xario	Antares	360-pin ZIF 
ULT-PA-27	GE	YMS/RT (for use with GR YMS/RT Transducers)	Call for Details	156-pin ZIF 
ULT-PA-29	Zonare	E9-4	All Zonare Platforms	168-pin Proprietary Custom Connector 
ULT-PA-30	GE Samsung	GE 4C-D, 6VT-D, Voluson E8, GE Vivid E9, Logiq E10 Samsung RS80A, HS70A,	Samsung DLP408	408 Pin ZIF connector, With Shutters 
ULT-PA-32	Sonosite	TEE X-Porte & T8-3	X-Porte	



“The BC Biomedical ULT-PA-19 adapter has been validated by Philips Ultrasound for use with the X7-2t, S7-3t, and S8-3t compact connector TEE transducers.”



**PHILIPS**

**FUJIFILM** **SONOSITE**  
Value from Innovation

**SIEMENS**



Did you know that all ultrasound transducer adapters are not created equally? There are basically two types of adapters available in the market today. The traditional adapters available from other manufacturers utilize a conductive rubber pad within a rigid body that captures the center mounting post of the transducer and pushes the pins of the transducer electrical connector into the surface of this relatively rigid conductive rubber pad. This action creates stress on the individual pins of the transducer connector and can actually bend or break pins under certain conditions.

Ultrasound manufacturers are aware of the existence of this type of adapter, and they will typically not provide warranty repairs to transducers with bent or broken pins caused by the use of these adapters. In fact, most ultrasound manufacturers frown upon the use of this type of adapter because of the physical stress placed upon the pins of the electrical connector. Replacement of a transducer electrical connector due to bent or broken pins can be a very costly experience.

Old Rubber Pad





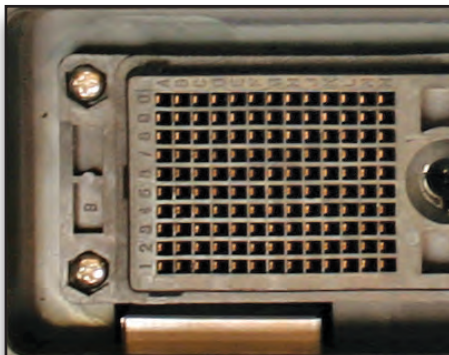

New “Soft Touch” Connector



The ULT line of second generation “Soft Touch” transducer adapters, available from BC Group International, completely eliminates the possibility of costly damage. Our second generation adapters utilize the actual multi-pin mating connector for the ultrasound transducer to be tested. The transducer electrical connector is subjected only to the same level of insertion and locking force that is normally seen when the transducer is connected to the ultrasound machine. There are no other undesired mechanical forces on the transducer electrical connector, or the individual pins within it. So why not take steps to avoid unnecessary and costly transducer electrical connector damage as a result of using older generation adapters? Second generation improved design adapters are now available from BC Group International.

			
ULT-PA-10	ULT-PA-11	ULT-PA-12	ULT-PA-13
			
ULT-PA-14	ULT-PA-16	ULT-PA-17	ULT-PA-18
			
ULT-PA-19	ULT-PA-20	ULT-PA-21	ULT-PA-22
			
ULT-PA-23	ULT-PA-24	ULT-PA-25	ULT-PA-26
			
ULT-PA-27	ULT-PA-29	ULT-PA-30	ULT-PA-32

Conductivity Probes

				
ULT-PC-10	ULT-PC-15	ULT-PC-20	ULT-PC-25	ULT-PC-30

Fork Adapter



ULT-AC-10

Splitter



ULT-SP-20

# POWER METERS WITH SOLID MEASUREMENT ACCURACY

77

Wattmeter Series



## USP-100SP

The USP-100SP Ultrasound Power Meter was developed to test therapeutic transducers according to AIUM, JCAHO, FDA and NIST guidelines. The compact and light weight USP-100SP meets all the requirements of a portable test instrument with the reliability and proven performance of the Series.

Both the USP-50SP and the USP-30 is designed to measure the ultrasound power output of diagnostic or therapeutic transducers up to 30 watts using the radiation force balance method.

This series of Wattmeters provides a sturdy instrument with solid measurement accuracy and economical cost.



## USP-100SP SPECIFICATIONS

Measure Range	0.2 to 30 Watts
Resolution	± 50 mW
Accuracy	± 3% +One Count Reading
Transducer Frequency	0.5 to 10 MHz
Maximum Transducer Diameter 3"	
Test Medium	Degassed, distilled water at normal room temp
Stabilization Time	2.5 sec
Display	3-Digit LCD, 1.3" High
Line Power	120 or 240 VAC Plug-in AC
Adapter	
Battery	4-AA, 20 hrs. continuous battery life
Dimensions	8.5" H x 12" L x 8.75" W



## USP-50SP SPECIFICATIONS

Power Range	0 to 30 Watts
Resolution	+ 50 mW, ± .01 gram
Minimum Detectable Power	0.05 Watts
Display Sensitivity	0.05 Watts
Accuracy	± 3% @10 Watts
Stabilization	2.5 Second Integration
Maximum Transducer Diameter	4 1/2" Inches
Transducer Operating Frequency	0.5 to 10 MHz
Test Medium	Degassed Water
Display	7 segment 6 Digit 0.6" (15mm) high LCD
Battery	4-AA: battery life over 40 hrs.; "Lo-Bat" Indicator
Power Supply	120 VAC to 12 VAC 500 mA adapter with 6 Ft. cord
Dimensions	7.0" H x 10.5" L x 8.5" W
Weight	10 Lbs



## USP-30 SPECIFICATIONS

Power Range	150 mW to 30 Watts
Resolution	± 150 mW
Minimum Detectable Power Level	± 150 mW
Minimum Accuracy	± 5%
Expected Accuracy	± 4%
Display	Vernier Dial
Display Sensitivity	± 0.01g or ± 150mW
Zeroing Method	Manually Adjusted
Test Tank Lining	0.5" neoprene rubber
Test Medium	Degassed, distilled water at normal room temp
Test Tank Liquid Capacity	1,350 mL
Test Tank Dimensions	Outside 5.75" Dia. x 5.55"
Inside	4.5" Dia. x 5.25" D
Cone Target	3.5" Dia. x 2" H
Dimensions(w/Case)	19" H x 17" L x 7" W
Power	Not required
Weight(w/Case)	18 Lbs

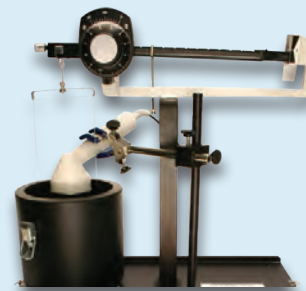

# ANESTHETIC ANALYZER BRAND COMPARISON

	BC Biomedical AA-8100	BC Biomedical AA-8000	BC Biomedical MGA-3050
Auto Agent ID	Yes	No	Yes
Dual Agent ID (Mixed Agent Detection)	Yes	No	Not Specified
Bench Technology	NDIR (Non-Dispersive Infrared)	NDIR (Non-Dispersive Infrared)	NDIR (Non-Dispersive Infrared)
Standalone Device	Yes	Yes	No (Requires PFC-3000 or Citrex H5)
<u>Agents Measured</u>			
Halothane, Isoflurane, Sevoflurane and Desflurane	Yes	Yes	Yes
<u>Environmental</u>			
Barometric Pressure and Temperature Compensation	Yes	Yes	Yes
Operating Altitude	10,000 ft	10,000 ft	10,000 ft
Operating Temperature	50 to 131 °F	50 to 131 °F	50 to 131 °F
<u>Gases Range</u>			
Halothane	0 to 8% Vol. %	0 to 8% Vol. %	0 to 12% Vol. %
Isoflurane	0 to 8% Vol. %	0 to 8% Vol. %	0 to 12% Vol. %
Sevoflurane	0 to 8% Vol. %	0 to 8% Vol. %	0 to 15% Vol. %
Desflurane	0 to 20% Vol. %	0 to 20% Vol. %	0 to 25% Vol. %
<u>Resolution</u>			
Halothane, Isoflurane and Sevoflurane	0.01% Vol. %	0.01% Vol. %	Not Specified
Desflurane	0.01% Vol. %	0.01% Vol. %	Not Specified
<u>Accuracy</u>			
Halothane	Range: 0 to 8% +/- (0.05% Vol% + 4% relative)	Range: 0 to 8% +/- (0.05% Vol% + 4% relative)	Range: 0 to 8% Range: 8 to 12% +/- (0.15% ABS + 5% REL) +/- (0.2% ABS + 10% REL)
Isoflurane	Range: 0 to 8% +/- (0.05% Vol% + 4% relative)	Range: 0 to 8% +/- (0.05% Vol% + 4% relative)	Range: 0 to 8% Range: 8 to 12% +/- (0.15% ABS + 5% REL) +/- (0.2% ABS + 10% REL)
Sevoflurane	Range: 0 to 8% +/- (0.05% Vol% + 4% relative)	Range: 0 to 8% +/- (0.05% Vol% + 4% relative)	Range: 0 to 10% Range: 10 to 15% +/- (0.15% ABS + 5% REL) +/- (0.2% ABS + 10% REL)
Desflurane	Range: 0 to 20% +/- (0.05% Vol% + 4% relative)	Range: 0 to 20% +/- (0.05% Vol% + 4% relative)	Range: 0 to 22% Range: 22 to 25% +/- (0.15% ABS + 5% REL) +/- (0.2% ABS + 10% REL)
<u>Physical</u>			
Weight	2.8 Lbs.	2.8 Lbs.	< 0.1 Lbs. (without cable)
Size	7.9" x 6.8" x 3.0"	7.9" x 6.8" x 3.0"	1.5" x 1.2" x 1.3"
<u>Other Features</u>			
Change Agent	One Button (Auto Detection and Dual Detection Available)	One Button	Auto-Detection Only
Reference Calibration	Automatic	Automatic	Not Specified
Data Logging	Manual, Automatic, Mobile (Android and iOS)	Manual & Automatic	Numerical Data and real-time curves using the FlowLab Software
Data Storage	1000 Records	500 Records	Numerical Data in the FlowAnalyzer
NIST Calibration Certificate Provided	Yes	Yes	No



# ANESTHETIC ANALYZER BRAND COMPARISON

	Riken FI-8000P	Fluke Vapor		
Auto Agent ID	No	Yes		
Dual Agent ID (Mixed Agent Detection)	No	Yes		
Bench Technology	Interferometer	NDIR (Non-Dispersive Infrared)		
Standalone Device	Yes	No (Requires VT-900A)		
<u>Agents Measured</u>				
Halothane, Isoflurane, Sevoflurane and Desflurane	Yes	Yes		
<u>Environmental</u>				
Barometric Pressure and Temperature Compensation	Not Specified	Yes		
Operating Altitude	Not Specified	10,000 ft		
Operating Temperature	68 to 122 °F	50 to 131 °F		
<u>Gases Range</u>				
Halothane	0 to 6% Vol. %	0 to 5% Vol. %		
Isoflurane	0 to 8% Vol. %	0 to 5% Vol. %		
Sevoflurane	0 to 10% Vol. %	0 to 8% Vol. %		
Desflurane	0 to 20% Vol. %	0 to 18% Vol. %		
<u>Resolution</u>				
Halothane, Isoflurane and Sevoflurane	0.01% Vol. %	Not Specified		
Desflurane	0.02% Vol. %	Not Specified		
<u>Accuracy</u>				
Halothane	Range: 0 to 6%	+/- (3% reading)(air)	Range: 0 to 1% Range: 1 to 5%	0.15% ABS 0.2% ABS
Isoflurane	Range: 0 to 8%	+/- (3% reading)(air)	Range: 0 to 1% Range: 1 to 5%	0.15% ABS 0.2% ABS
Sevoflurane	Range: 0 to 10%	+/- (3% reading)(air)	Range: 0 to 1% Range: 1 to 5% Range: 5 to 8%	0.15% ABS 0.2% ABS 0.4% ABS
Desflurane	Range: 0 to 20%	+/- (3% reading)(air)	Range: 0 to 1% Range: 1 to 5% Range: 5 to 10% Range: 10 to 15% Range: 15 to 18%	0.15% ABS 0.2% ABS 0.4% ABS 0.6% ABS 1.0% ABS
<u>Physical</u>				
Weight	2.5 Lbs.	1.1 Lbs.		
Size	6.1" x 5.0" x 3.2"	7.6" x 3.8" x 2.5"		
<u>Other Features</u>				
Change Agent	One Button + Requires Manual Reference Calibration After Changing Agent	(Auto Detection Only)		
Reference Calibration	Manual	Not Specified		
Data Logging	Manual & Automatic	Manual		
Data Storage	256 Records	Yes (Records saved on VT-900A)		
NIST Calibration Certificate Provided	No	Yes		

# NIBP SIMULATOR BRAND COMPARISON

## Why Should I Purchase a NIBP-1040?

Non-Invasive Blood Pressure Simulator Comparison Chart

Features:	BC Biomedical NIBP-1040 Kit™	Fluke ProSim 8™	Fluke ProSim 4™	Pronk SC-5 SimCube™	Pronk SC-4 Simcube™	Clinical Dynamics AccuPulse™	Rigel BP-SIM™
NIBP Simulation	Included	Included	Included	Included	Included	Included	Included
Manometer	Included	Included	Included	Included	Included	Included	Included
SpO <sub>2</sub>	Optional	Optional	Not Available	Not Available	Not Available	Not Available	Not Available
ECG Simulation	Included	Included	Included	Included	Included	Included	Not Available
Performance Waveform	Included	Included	Not Available	Not Available	Not Available	Included	Not Available
Patient Simulation	Included	Included	Included	Included	Included	Optional	Not Available
Pacer	Included	Included	Included	Included	Included	Optional	Not Available
Respiration	Included	Included	Included	Included	Included	Optional	Not Available
IBP Simulation	Included	Included	Included	Included	Not Available	Optional	Not Available
Temperature	Included	Included	Not Available	Not Available	Not Available	Optional	Not Available
Arrhythmias	Included	Included	Included	Included	Not Available	Optional	Not Available
Leak Detection	Included	Included	Included	Included	Not Available	Included	Included
Extended Leads	Included	Included	Not Available	Not Available	Not Available	Optional	Not Available
Cardiac Output	Included	Included	Not Available	Not Available	Not Available	Not Available	Not Available
Fetal/Maternal	Included	Included	Not Available	Not Available	Not Available	Not Available	Not Available
Internal Battery	Included	Included	Included	Optional	Optional	Included	Included
Peak Detection	Included	Included	Not Available	Included	Included	Included	Included
Alarm	Included	Included	Included	Included	Included	Not Available	Not Available

## Why Should I Purchase an ESU-2400?

ESU Comparison Chart

Item	BC Biomedical ESU-2400H™	BC Biomedical ESU-2400™	BC Biomedical ESU-2350™	BC Biomedical ESU-2050P™	Rigel Uni-Therm™	Fluke Biomedical QA-ES III™
1% Measurement Accuracy	Included	Included	Not Available	Included	Not Available	Not Available
Current Measurement Method	Included	Included	Included	Included	Included	Included
1 Ohm Load Resolution	Included	Included	Not Available	Not Available	Not Available	Not Available
Tissue Response Simulation	Optional	Optional	Not Available	Not Available	Not Available	Not Available
High Crest Factor	Included	Included	Included	Included	Not Available	Not Available
1 % REM/CQM/ARM Accuracy	Included	Included	Included	Optional	Not Available	Not Available
Basic Pulsed Mode Measurement	Included	Included	Not Available	Included	Not Available	Not Available
Advanced Pulsed Mode Measurements	Included	Not Available	Not Available	Not Available	Not Available	Not Available
Fully Automated PM procedure for ForceTriad™ 101 steps	Included	Included	Not Available	Not Available	Not Available	Not Available
Communication with DUT	Included	Included	Not Available	Not Available	Not Available	Not Available
Required loads for ForceTriad™ Autobipolar Testing	Included	Included	Included	Not Available	Included	Not Available
Easy to use Touch Screen Interface	Included	Included	Included	Not Available	Not Available	Not Available
Automated Software Updates through web interface	Included	Included	Included	Not Available	Not Available	Not Available
Networking ability for virtually unlimited data storage	Included	Included	Included	Not Available	Not Available	Not Available
Can save test results to PDF format locally for maximum stand-alone operability	Included	Included	Included	Not Available	Not Available	Not Available



# BC Group

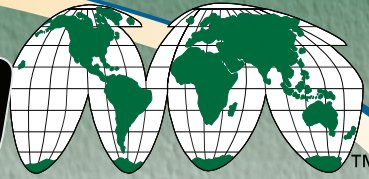

YOUR ONE-STOP BIOMED SHOP

## Featured Vendor Alliance Products



**NEW**
**AG**  
 INSTRUMENTS

**MGV100**

The MGV100 is the world's only all-in-one NFPA99 gas analyzer which provides MGVs with the ultimate combination of measurement accuracy, speed and convenience in an ergonomic, light and compact design.

The MGV100 is based on AG Instruments patented technology and the **Technology Made to Measure™** concept. It was developed by bringing together some of the most experienced piped medical gas verifiers in the world with top gas analysis design engineers to offer you a product of the highest standards.

The MGV100 measures O<sub>2</sub>, N<sub>2</sub>O, Water Vapor, CO<sub>2</sub>, CO, Gaseous HC, Halogenated HC, gas pressure and vacuum. It has advanced infrared, electrochemical, PID and (optional) paramagnetic sensors to provide the most accurate results.



### All NFPA99 Gas Testing in One Instrument

- ◆ Measures O<sub>2</sub>, N<sub>2</sub>O, Water Vapor, CO<sub>2</sub>, CO, GHC, HHC, gas pressure and vacuum.
- ◆ Optional US Pharmacopeia SO<sub>2</sub>, NO and NO<sub>2</sub> using electrochemical sensors.
- ◆ Connects directly to any gas outlet with gas pressure up to 190 psi (13 Bar).
- ◆ The most comprehensive, efficient and convenient piped medical gas testing solution in the world.

### Reliable Technologies

- ◆ Simultaneous measurement of all NFPA-99 gases.
- ◆ Most advanced sensing technologies.
- ◆ Infrared Absorption water vapor measurement - much faster than current capacitive, electronic or chilled mirror sensors.
- ◆ Infrared Absorption sensors for N<sub>2</sub>O, CO<sub>2</sub> and Gaseous Hydrocarbons.
- ◆ High stability electrochemical sensor for O<sub>2</sub> (optional paramagnetic sensor).
- ◆ High sensitivity Electrochemical cell to measure CO down to 0.01 ppm.
- ◆ Photo Ionization Detector with ppb sensitivity to measure halogenated hydrocarbons.

### Automatic Air Calibration

- ◆ No air bottle is needed to perform air calibration.
- ◆ Built-in filter provides dry and clean air for automatic air calibration when needed.
- ◆ Precise temperature and pressure compensations for stable readings and reduced user gas calibration.

### Simple and Reliable Gas Connections

- ◆ Direct connection to any gas outlet through a robust stainless-steel braided hose.
- ◆ No need for pressure or flow regulators.
- ◆ Hose is PTFE-lined and sealed to minimize hose purging time and ensures gas sample integrity.
- ◆ Safe gas discharge of hazardous gas using one vent tube.
- ◆ Simple operation, gas connections, handling as well as data recording provide optimal and streamlined operation.

### Secure and Complete Data Recording and Reporting

- ◆ Password protected access to ensure the integrity of the tests.
- ◆ Test results are shown with out-of-range values highlighted according to NFPA99.
- ◆ Gas test results, particulates, oil and odor results are securely stored with sample IDs and user notes.
- ◆ Data can be uploaded to the supplied MGVReports PC Software.
- ◆ Data can also be exported to a USB memory stick.
- ◆ The MGVReports air plant monitoring option provides real-time logging of gas readings for up to an hour with tabular and graphic presentation of the results.

### Maximum Convenience

- ◆ The MGV100 is compact and light: 11.5 lb/ 5.2kg.
- ◆ Accessories bag fits inside the instrument case.

**DIAGNOMATIC** by **Pro-Project**<sup>®</sup>

Pro-Project was established in 1991. Many years of experience in Quality Assurance and Quality Control in industrial and medical imaging as well as radiotherapy equipment helped us develop and manufacture a wide range of quality assurance devices (phantoms) along with supporting applications and services.

## Pro-MRI ACR Medium



### Product features:

### ACR Accredited complies with:

- ✦ ACR MRI Accreditation Program
- ✦ IPEM Report 80 "Quality Control in MRI", 1998
- ✦ AAPM Rep. 28 "Quality Assurance methods & phantoms for MRI", 1990
- ✦ AAPM Rep. 34 "Acceptance testing of MRI systems", 1992
- ✦ AAPM Rep. 100 "Acceptance & Quality Assurance procedures for MRI facilities", 2010
- ✦ CE certified the manual provides detailed guidelines for carrying out each test, results assessment and registration





## Technical data:

- ◆ Outside cylinder diameter: 178 mm
- ◆ Outside cylinder height: 157 mm
- ◆ Inside cylinder diameter: 165 mm
- ◆ Inside cylinder height: 134 mm
- ◆ filled with 10 mmol nickel chloride solution containing sodium chloride 75 mmol
  
- ◆ **The outside of each phantom has the words “NOSE” and “CHIN” etched into it as an aid to orienting the phantom for scanning, as if it were a head resolution insert:**
  - ▶ Four matrices of holes, diameters: 0.8, 0.9, 1.0 and 1.1 mm spaces between the holes are equal to hole diameters
  
- ◆ **Two small containers with water and fat for water-fat shift evaluation slice thickness insert:**
- ◆ 158 x 52 x 10 mm PMMA plate
- ◆ 1 mm wide and 5 mm deep counter-descending slits on both sides
  
- ◆ **Slits form two ramps descending at 1:10 geometric distortion insert:**
  - ▶ 3x3 holes array, 40 mm spacing,
  - ▶ 2 mm diameter
  - ▶ 120 mm on a side
  
- ◆ **10 mm thick low contrast insert:**
  - ▶ Partial volume contribution of these sheets and filling solution produce contrasts: 1.4, 2.5, 3.6 and 5.1%
  - ▶ Each disc contains 10 groups of 3 holes arranged in spokes
  - ▶ Each spoke has the same diameter
  - ▶ Diameters range from 7.0 to 1.5 mm
  - ▶ Four sets of paired 45° wedges are located on both sides of the phantom
  - ▶ The lower pairs are 20 x 20 mm, and the upper ones are 30 x 30 mm
  - ▶ Heavy duty carrying case (09-102)
  - ▶ Optional detachable 3-axis spirit level (09-104)



## IMT.Analytics CITREX H5

The ideal all-in-one testing device for biomedical engineers, independent service organizations, anesthesia device and ventilator manufacturers. CITREX H5 is the gas flow and pressure measurement instrument with the most advanced user interface. It's portable, accurate and enables users to individually configure their measuring screens.

The CITREX H5 is designed to meet a wide variety of day-to-day applications. Its precise and highly reliable capabilities allow it to analyse the performance of different medical devices such as ventilators and anaesthesia machines or oxygen flow meters, pressure gauges and suction devices.

CITREX H5 was developed in order to measure flow and various pressures and thus calculate a large number of ventilation parameters. CITREX H5 is a compact, mobile and easy-to-operate measuring instrument. The integrated oxygen sensor makes it possible for users to determine the oxygen concentration. The instrument is controlled on a 4.3" multi-touch display and it has a large number of different interfaces for data analysis.

IMT Analytics also has the CITREX H4 and CITREX H3. The CITREX H4 gas flow analyzer is designed for mobile and easy use while still meeting all requirements of day-to-day field operations. Its capabilities allows it to analyze the performance of a wide variety of medical devices. The CITREX H3 provides the necessary functions required to test and validate the performance of respiratory ventilators. Its compact and lightweight design make the CITREX H3 a small and powerful tool.



Flow and pressure measurements		
Flow	Flow	± 300 sL/min*** ± 1.9%* or ± 0.1 L/min**
Measuring direction bidirectional		Yes
Temperature compensated		Automatic
Pressure compensated		Automatic
Humidity compensated		Manually
Pressure		
High	P <sub>High</sub>	0–10 bar ± 1%* or ± 10 mbar**
Differential	P <sub>Diff</sub>	± 200 mbar ± 0.75%* or ± 0.1 mbar**
Flow channel	P <sub>Channel</sub>	-50 –150 mbar ± 0.75%* or ± 0.1 mbar**
Atmospheric pressure	P <sub>Atmo</sub>	500 –1150 mbar
Units		
Flow		L/min, L/s, cfm, mL/min, mL/s
Pressure		bar, mbar, cmH <sub>2</sub> O, Torr, inHg, hPa, kPa, mmHg, PSI
Other measurement		
Oxygen (pressure comp. ≤ 150 mbar)	O <sub>2</sub>	0 –100% ± 1% O <sub>2</sub> **
Gas temperature	Temp.	0 –50 °C ± 1.75%* or ± 0.5 °C**
Gas types		Air, Air/O <sub>2</sub> , O <sub>2</sub> , N <sub>2</sub> O, N <sub>2</sub> O/O <sub>2</sub> , CO <sub>2</sub> , N <sub>2</sub> , Heliox (21% O <sub>2</sub> )
Gas standards		ATP, ATPD, ATPS, AP21, STP, STPH, BTPS, BTPS-A, BTPD, BTPD-A, 0/1013, 20/981, 15/1013, 25/991, 20/1013, NTPD, NTPS
Ventilation parameter		
Breath rate	Rate	1–1000 AZ/min ± 1 AZ/min* or ± 2.5%**
Time	T <sub>i</sub> , T <sub>e</sub>	0.05 –60 s ± 0.02 s
Ratio	I:E	1:300–300:1 ± 2.5%*
	T <sub>i</sub> /T <sub>cyc</sub>	0 –100% ± 5%*
Volume	V	± 2%* or ± 0.20 mL (>6 sL/min)**
Tidal Volume	V <sub>ti</sub> , V <sub>te</sub>	± 10 L ± 2%* or ± 0.20 mL (>6 sL/min)**
Minute volume	V <sub>i</sub> , V <sub>e</sub>	0 –300 sL/min ± 2.5%*
Peak flow	PF <sub>insp</sub> , PF <sub>exp</sub>	± 300 sL/min ± 1.9%* or ± 0.1 sL/min**
Pressure	P <sub>Peak</sub> , P <sub>Mean</sub> , PEEP, P <sub>Plateau</sub> , IPAP	0 –150 mbar ± 0.75%* or ± 0.1 mbar**
Compliance	C <sub>Stat</sub>	0 –1000 mL/mbar ± 3%* or ± 1 mL/mbar**
General information		
Realtime curves		Yes
Display		4.3" Multi-Touch (color)
Interface		RS-232, USB, Ethernet, CAN, Analog Out, TTL, WLAN
Data storage		Internal and Micro SD Memory Card
Power		100 –240 VAC, 50 –60 Hz
Dimension (w × d × h)		11.4 × 7 × 7.3 cm
Weight		0.52 kg
Battery		5 hours
Approvals		CE, CSA (Canada and USA)

The greater tolerance is valid: \* Tolerance related to the measured value, \*\* Absolute tolerance,  
\*\*\* The unit sL/min is based on ambient conditions of 0 °C and 1013.25 mbar (DIN 1343).

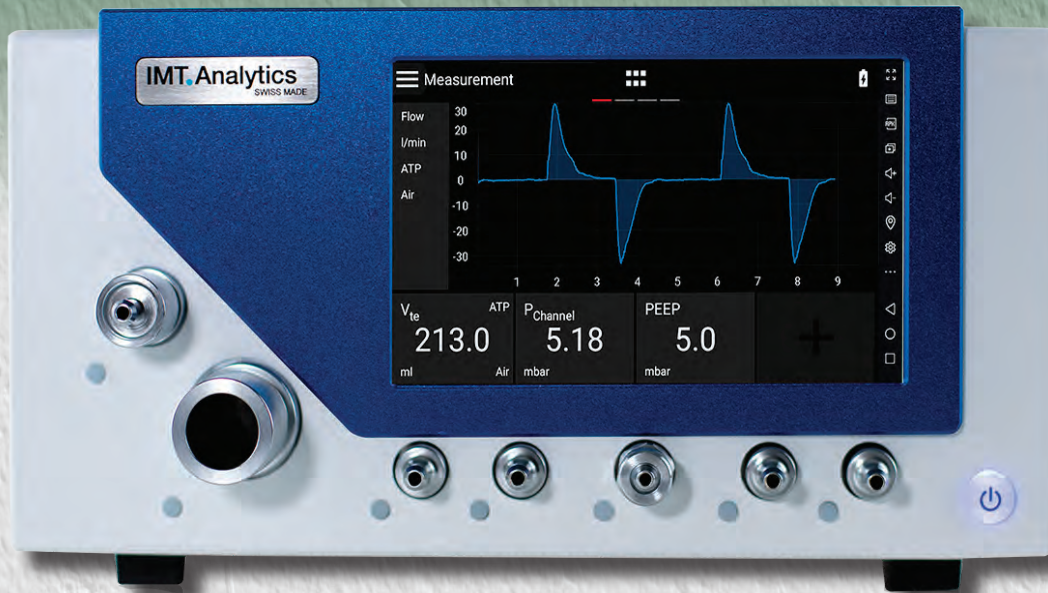

# IMT.Analytics

## PF-300 PRO

The FlowAnalyser PRO, with ultimate performance and configurability, enables a wide range of professionals to push the limits of what is possible. Thanks to its extreme precision and reliability, the FlowAnalyser PRO is capable of testing a wide range of medical devices such as respiratory and anesthesia devices, oxygen flow meters, pressure gauges and suction devices.

The FlowAnalyser PRO offers a beautiful, high resolution multitouch user interface that is completely configurable. Apps with Test Sequences Run tests easier and faster with our apps. The FlowAnalyser PRO ventilator tester supports you with apps for testing and calibrating many devices. The apps enable safe and fast testing.

Measure breath based respiratory parameters with automatic trigger detection for conventional and high-frequency medical ventilators. Entire test sequences are displayed with images and texts and measured automatically. The test results are recorded in a PDF report, which can be signed directly on the screen.

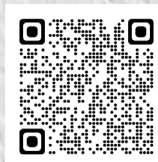

Flow and pressure measurements		Range	Accuracy
Flow	Measuring direction	Bidirectional	
	Temperature compensated	Automatic	
	Pressure compensated	Automatic	
	Humidity compensated	Automatic	
	O <sub>2</sub> compensated	Automatic	
	Flow	± 300 L/min	± 1.65%* or ± 0.04 L/min (for 10..40°C)**
	Ultra-Low Flow	± 1 L/min	± 1.65%* or ± 0.01 L/min (for 10..40°C)**
Pressure	High Pressure & Vacuum (P <sub>High</sub> )	-1 – 10 bar	± 1%* or ± 7 mbar**
	Differential Pressure (P <sub>Diff</sub> )	± 250 mbar	± 0.5%* or ± 0.1 mbar**
	Low Differential Pressure (P <sub>DiffLow</sub> )	-10 – 10 mbar	± 1%* or ± 0.01 mbar**
	Pressure in Flow Channel (P <sub>Channel</sub> )	-50 – 160 mbar	± 0.5%* or ± 0.1 mbar**
	Atmospheric Pressure (P <sub>Atmo</sub> )	500 – 1240 mbar	± 1%* or ± 5 mbar**
Units	Flow	L/min, L/s, cm, mL/min, mL/s	
	Pressure	bar, mbar, cmH <sub>2</sub> O, inH <sub>2</sub> O, Torr, inHg, hPa, kPa, mmHg, PSI	
Additional measurements		Range	Accuracy
Oxygen	Concentration	0 – 100 %	± 1 % O <sub>2</sub> **
	Pressure compensated	≤ 150 mbar	
Temperature	In Flow Channel	0 – 50 °C	± 1.75%* or ± 0.5 °C**
Dew point	In Flow Channel	-10 – 50 °C	± 2%* or ± 1 °C**
Humidity	In Flow Channel	0 – 100% RH (non condensing)	± 3% RH ** from 10% RH to 80% RH ± 5% RH ** for <10% and >80% RH
CO <sub>2</sub>	Concentration (with optional OR-703)	0 – 15 vol%	± (0.2 vol% + 2% of reading)
		15 – 25 vol%	unspecified
N <sub>2</sub> O	Concentration (with optional OR-703)	0 – 100 vol%	± (2% vol% + 2% of reading)
HAL, ISO, ENF	Concentration (with optional OR-703)	0 – 8 vol%	± (0.15 vol% + 5% of reading)
		8 – 25 vol%	unspecified
SEV	Concentration (with optional OR-703)	0 – 10 vol%	± (0.15 vol% + 5% of reading)
		10 – 25 vol%	unspecified
DES	Concentration (with optional OR-703)	0 – 22 vol%	± (0.15 vol% + 5% of reading)
		22 – 25 vol%	unspecified
Gas types	Air, O <sub>2</sub> , Air/O <sub>2</sub> , N <sub>2</sub> O/O <sub>2</sub> , He, He/O <sub>2</sub> , N <sub>2</sub> , N <sub>2</sub> O, CO <sub>2</sub> , customised gas types		
Gas standards	ATP, ATPD, ATPS, AP21, AP25, STP, STPD0, STPD20, STPD21, STPH, BTPS, BTPS-A, BTPD, BTPD-A, 0/1013, 20/981, 15/1013, 25/991, 20/1013, 23/1013, NTPD, NTPS		
Respiratory parameters		Range	Accuracy
Breath rate	Rate	1 – 2000 bpm	± 1 bpm or ± 1%**
Time	Inspiratory time (T <sub>i</sub> )	0 – 60 s	± 0.01 s
	Expiratory time (T <sub>e</sub> )	0 – 90 s	± 0.01 s
	Inspiratory hold time	0 – 60 s	± 0.01 s
	Expiratory hold time	0 – 90 s	± 0.01 s
	Post-inspiratory pause (% T <sub>p</sub> )	0 – 100 %	± 0.1 %
Ratio	I:E	1:300 – 300:1	± 2%*
	T <sub>i</sub> /T <sub>total</sub>	0 – 100 %	± 5%*
Breath volume	V <sub>ti</sub> , V <sub>te</sub>	± 60 L	± 1.75%* or ± 0.10 mL
Minute volume	V <sub>i</sub> , V <sub>e</sub>	0 – 300 sL/min	± 1.75%* or ± 5 mL
Pressure	P <sub>Peak</sub> , P <sub>Mean</sub> , PEEP, P <sub>Plateau</sub>	0 – 160 mbar	± 0.75%* or ± 0.1 mbar**
Peakflow	PF <sub>Insp</sub> , PF <sub>Exp</sub>	± 300 sL/min	± 1.65%* or ± 0.04 sL/min**
Compliance	C <sub>Stat</sub>	0 – 1000 mL/mbar	± 3%* or ± 0.01 mL/mbar**
Trigger	Automatic, Adult, Pediatric, HFO, ext. Trigger	Adult, Pediatric, HFO; Adjustable on flow or pressure curves with user-defined limits.	
General information			
Power	100 – 240 VAC, 50 – 60 Hz		
Battery operation	16 hours		
Power consumption	Typical 5 VA, max. 25 VA (during battery charging)		
Weight	3.2 kg		
Dimensions (w x d x h)	24 x 26 x 13 cm		
Data Storage	Internal, USB stick		
Display	High resolution touch-screen display 5" (800 x 480 px)		
Interfaces	USB-A for USB stick, USB-B for FlowLab Software, individual communication, TTL for external trigger, RS232		
Calibration	Annually		
Operating temperature	10 – 40 °C (50 – 104 °F)		
Operating Humidity	10 – 90 % R.H.***		
Approvals	CE, CSA (North America), IEC 61010-1:2010, IEC 61326-2:2012		

The greater tolerance is valid:

\*Tolerance related to the measured value, \*\* Absolute tolerance, with steady air flow, \*\*\* Non-condensing, \*\*\*\* The unit sL/min is based on ambient conditions of 0 °C and 1013.25mbar (DIN 1343).



The AMM-15 portable Dew Point Meter (Air-Line Moisture Monitor) is designed to measure the performance of drying systems for air, nitrogen and other compressed gases.

It is ideal for monitoring medical, commercial and industrial applications including: Plastics resin dryers, breathing air, pneumatic tools, instrument air and spraying/coating applications.

The AMM-15 measures dew point by utilizing microprocessor circuitry to convert the voltage output of OHMIC's HC-610 precision water vapor sensor and a temperature sensor to dew/frost point temperature by the use of psychrometric equations.

It is assembled in a rugged hand-held ABS plastic enclosure and equipped with quick disconnect tubing couplings and an internal sensor manifold. Heat sink tubing is available for sampling from drying systems and ovens up to 550 °F ( depending on ambient temperature). The AMM-15 can also be connected to a vacuum pump for sampling from piping, ovens, tanks or manifolds operating at ambient or low pressure.



# SPECIFICATIONS

OHMIC Air Line Moisture Monitor

<b>Water Vapor Sensor</b>	HC-610 (Integrated Thin Film Polymer)
<b>Temperature Sensor</b>	10K NTC Thermistor
<b>Dew Point Range</b>	-40 to 80 °F (-40 to 27 °C)
<b>Dry Bulb Temperature Range</b>	0-200 °F (-18 to 93 °C)
<b>Dew Point Accuracy</b>	±4 °F Dew point from -40 to 20 °F±2 °F Dew point from 20 to 80 °F
<b>Dry Bulb Accuracy</b>	±1 °F (-17.2 °C)
<b>Maximum Inlet Temperature</b>	185 °F (85 °C)Heat Sink Tubing Permits Maximum Inlet Temperature to 550 °F (288 °C) (depending on ambient temp.)
<b>Sensor Response Time</b>	10 Seconds for 63% Step Change
<b>Display Type</b>	3-1/2 Digit LCD; 0.5"
<b>Analog Outputs</b>	0 to 1 VDC
<b>Power</b>	6 VDC, (4) AA Batteries & 120 VAC Adapter
<b>Battery Life</b>	35 Hours Nominal
<b>Inlet Sample Port</b>	Quick Disconnect for 1/4" OD Tubing
<b>Inlet Pressure</b>	120 PSIG Max
<b>Computer Interface</b>	Bi-Directional RS-232. ASCII Delimited Format, 9600 Baud, 8 Bits, 1 Stop, 1 Start, No Parity
<b>Software Required</b>	HyperTerminal or PROCOMM
<b>Data Logger</b>	32 KByte, Non-Volatile Memory
<b>Internal Clock</b>	MM:DD:YY HH:MM:SS Military Time Format
<b>Dimensions</b>	8.25" x 4.0" x 1.6", ABS Plastic Enclosure
<b>Weight</b>	2 Lbs Net (0.9 Kg)



## UPM-DT-1000PA

OHMIC Instruments Newest Model UPM-DT-1000PA provides the fastest response (under 3 seconds) and the highest resolution (0.001 watts) of any current UPM-DT. The UPM-DT series have been in use worldwide since 1986 and conform to the testing guidelines recommended by FDA, JCAHO, AAMI and AIUM. Power is measured by the radiation force balance method. The accuracy of the UPM-DT's are traceable to NIST.

The most reliable and repeatable means of measuring ultrasound power is the radiation force balance method. The transducer to be tested is centered above a 45° air-backed cone target in water media, which is linked to a precision balance capable of resolving 0.1 mg.

OHMIC Instruments Models UPM-DT-1000PA, UPM-DT-10PA, and UPM-DT-1 PA are precision wattmeters designed to measure the power output of diagnostic and therapeutic ultrasound transducers.

To learn more about this series of Wattmeters, browse our [BCGroupStore.com](http://BCGroupStore.com) to download datasheets or look up product pricing. If you need a direct quote for a purchase order, feel free to call one of our friendly staff members.





# SPECIFICATIONS



**OHMIC Power Meter Series**

	UPM-DT-1000PA	UPM-DT-1PA	UPM-DT-10PA	UPM-DT-100SP	UPM-DT-50SP	UPM-30
Power Range	0- 30 Watts	0- 30 Watts	0- 30 Watts	0- 30 Watts	0- 30 Watts	0- 30 Watts
Transducer Range	0.5-10MHz	0.5-10MHz	0.5-10MHz	0.5-10MHz	0.5-10MHz	0.5-10MHz
Resolution	1 mW	2 mW	20 mW	200 mW	50 mW	±150mW
Display Sensitivity	0.001 Watt	0.002 Watt	0.02 Watt	0.2 Watt	0.05 Watt	N/A
Accuracy	± 3% @10 Watts, 25°C	± 3% @10 Watts, 25°C	± 3% @10 Watts, 25°C	± 3% @10 Watts, 25°C	± 3% @10 Watts, 25°C	± 5%
Zeroing Method	Push to Zero	Push to Zero	Push to Zero	Push to Zero	Push to Zero	Vernier Dial
Stabilization	<3.0 Second Integration	≤3.0 Second Integration	≤3.0 Second Integration	≤3.0 Second Integration	≤3.0 Second Integration	N/A
Cone Target Size	3.25" diameter x 1.125" high	3.25" diameter x 1.125" high	3.25" diameter x 1.125" high	3.25" diameter x 1.125" high	3.25" diameter x 1.125" high	3.25" diameter x 1.125" high
Test Media	Degassed Water	Degassed Water	Degassed Water	Degassed Water	Degassed Water	Degassed Water
Max Transducer Size	4 1/2" Diameter	4 1/2" Diameter	4 1/2" Diameter	4 1/2" Diameter	4" Diameter	4 1/2" Diameter
Computer Interface	RS-232, 600-19200 Baud *USB Optional	RS-232, 600-19200 Baud *USB Optional	RS-232, 600-19200 Baud *USB Optional	RS-232, 600-19200 Baud *USB Optional	RS-232, 600-19200 Baud *USB Optional	Does not apply
Power	120 VAC/12 VAC 500 mA adapter 6 Ft. cord	120 VAC/12 VAC 500 mA adapter 6 Ft. cord	120 VAC/12 VAC 500 mA adapter 6 Ft. cord	120 VAC/12 VAC 500 mA adapter 6 Ft. cord or 4 AA's	120 VAC/12 VAC 500 mA adapter 6 Ft. cord or 4 AA's	Not required
EMI Rating	CE, CSA, UL	CE, CSA, UL	CE, CSA, UL	CE, CSA, UL	CE, ICES	N/A
Electrical Safety	CE, CSA	CE, CSA	CE, CSA	CE, CSA	CE, ICES	N/A
Size	11"H x 15" L x 10"W	11"H x 15" L x 10"W	11"H x 15" L x 10"W	8"H x 12" L x 8.75"W	7"H x 10.5" L x 8.5"W (In case) * 6"H x 16.75" L x 12"W (assembled)	19"H x 17" L x 7"W
Weight	16 Lbs Net	16 Lbs Net	16 Lbs Net	11 Lbs Net	8.5 Lbs * 9.75 Lbs Net	18 Lbs Net
Carrying Case	Black Anodized Aluminum	Black Anodized Aluminum	Black Anodized Aluminum	Black Anodized Aluminum	Molded polyethylene	Black Anodized Aluminum

← For product pricing- please see page 160 →



piranha

## Piranha MULTI

The Piranha MULTI is all you need for qualified diagnostics and QA on Rad/Fluoro, CT, Dental, and Mammography X-ray scans.

Measures kVp, Time, HVL, Total Filtration, Dose, Dose rate, presents Waveform, and much more. See specifications for further information. Customize your measurements and reports with Ocean Next™ software.

Ocean Next™ software is quick and therefore your daily QA-work will go quickly. Ocean can perform instant real-time analysis during your measurements. Ocean also prepares a report in the background as you go. So when the work is done, if you want a complete report of your work – just press print!

Use your tablet/laptop as both an interactive display during the measurements and as a powerful analysis tool. All your measurements, along with the result and the report will be stored inside your tablet or laptop. No unnecessary, time-consuming data-transfer.

Just plug n play. The Quick Check feature identifies your probe and selects the optimum Piranha settings for your measurements. During the measurements you will only see the desired values on your tablet or laptop but since the Piranha continues to work behind the scenes, you have instant access to all of the data from each measurement. This enables you to perform trend analysis and history analysis.

The Piranha comes ready-to-use with everything you need included. The number of Piranha models available ensures that you only pay for what you need. As your needs grow, you have unlimited ability to upgrade your Piranha.



# COMPARISON CHART



Piranha meters	MULTI (657)	R/F (557)	CT (455) CTDp	CT (455) IC	MAMMO (355)	DENTAL (255)
Tablet compatible	•	•	•	•	•	•
Ocean software compatible	•	•	•	•	•	•
Waveform	•	•	•	•	•	•
Dose & Dose rate	•	•	•	•	•	•
Quick HVL	•	•	•	•	•	•
R/F	•	•				
Mammography	•				•	
Dental	•	•				•
CT	•	•	•	•		
kVp & Time	•	•	•	•	•	•
HVL & Total Filtration	•	•	•	•	•	•
RTI Dose Probe	•	•	•	•	•	•
RTI CT Dose Profiler	•	•	•	•	•	•
RTI CT Ion Chamber	•	•	•	•	•	•
RTI Mas-1, Mas-2, & Light Probe	•	•	•	•	•	•

• Standard function • Optional

R/F..... Meters for radiography and fluoroscopy.

Mammography..... Meters for mammography.

CT..... Meters for CT.

Dental..... Meters for dental (intraoral, panoramic and CBCT).

Dose Probe ..... Useful when higher sensitivity and minimal perturbation of field are required.

CT Dose Profiler..... For CT dose profile measurement.

CT Ion Chamber ..... To acquire all standard CTDI parameters.





## Cobia SMART R/F

For Rad/Fluoro as well as Intraoral & CBCT measurements. Measures kV, Dose, Dose Rate, Time, Total Filtration, HVL, and more.

Cobia SMART R/F comes with Bluetooth and USB connectivity which makes it possible to use it together with the Ocean Next™ software on a laptop, PC, or tablet.

Cobia SMART R/F has a clear and rotatable color display which easily can be read – even from a distance.

If the meter is facing down, just flex the display to read the figures.

The Ocean Next™ software exhibits Cobia's capabilities and adds benefits that make the workflow more practical and simpler. The software makes it possible to perform remote X-ray testing measurements with your Cobia SMART R/F. You simply connect to your Cobia, with a USB cable to your PC or tablet, then measure!



# COMPARISON CHART



Available models	Cobia SMART R/F	Cobia FLEX R/F		Examples of Cobia SENSE				Cobia DENTAL
	kV & Dose	R/F	w. mAs	R/F	Mammo	CTDP	CT IC	DENTAL
Mammography	NO	EXT	EXT	EXT	X	EXT	EXT	NO
Rad & Fluoro	X	X	X	X	EXT	EXT	EXT	NO
Dental	X	X	X	X	EXT	EXT	EXT	X
CT	NO	EXT	EXT	EXT	EXT	X	X	NO
kV	INT	INT	INT	NO	NO	NO	NO	X
Time	INT	I/E	ALL	X	X	X	X	X
Dose	INT	I/E	I/E	X	X	(CTDI)	(CTDI)	X
Dose Rate	INT	I/E	I/E	X	X	NO	NO	X
HVL	INT	INT	INT	X	X	NO	NO	X
Total Filtration	INT	INT	INT	X	X	NO	NO	X
# Pulses	INT	I/E	ALL	X	X	NO	NO	X
Pulse Rate	INT	I/E	I/E	X	X	NO	NO	X
Dose/Pulse	INT	I/E	I/E	X	X	NO	NO	X
Effective time	INT	I/E	ALL	X	X	NO	NO	X
Internal mAs	NO	NO	X	NO	NO	NO	NO	OPT
Ocean™ compatibility	X	X	X	X	X	X	X	X
OCP	X	X	X	X	X	X	X	X
Bluetooth connection	X	X	X	X	X	X	X	X
RTI Soft Shell Case	X	X	X	X	X	X	X	X
Dose Probe	NO	OPT	OPT	X	X	OPT	OPT	OPT
Mas-1	NO	OPT	OPT	OPT	OPT	OPT	OPT	OPT
Mas-2	NO	OPT	OPT	NO	NO	NO	NO	OPT
CTDP	NO	OPT	OPT	OPT	OPT	X	OPT	OPT
CT Ion Chamber	NO	OPT	OPT	OPT	OPT	OPT	X	OPT
Light Probe	NO	OPT	OPT	OPT	OPT	OPT	OPT	OPT
DAP Chamber	NO	OPT	OPT	OPT	OPT	OPT	OPT	OPT

X = Included or possible INT = With internal detector (only) NO = Not possible OPT = Optional EXT = Extra probe/cal. of probe needs to be purchased \*MAS-2 cannot be used with Cobia SENSE I/E = Internal or External ALL = Interna, External, or Internal mAs

Rad & Fluoro.....Meters for radiography and fluoroscopy.  
 Mammography .....Meters for mammography (not kVp).  
 CT .....Meters for CT.  
 Dental .....Meters for dental (intraoral or CBCT).  
 OCP .....Open Communication Protocol.

Dose Probe .....Useful when higher sensitivity and minimal perturbation of field are required.  
 CTDP .....CT Dose Profiler for CT dose profile measurement.  
 CTDI.....CTDI parameters.  
 CT Ion Chamber.....To acquire all standard CTDI parameters.

NEW



NEW



CERTIFIER™ PLUS



CERTIFIER™ PRO



The **Certifier™ Plus** and **Certifier™ Pro** Flow Analyzers are multi-functional pneumatic test systems that combine flow, pressure, temperature, and oxygen concentration measurements. Certifier Flow Analyzers utilize TSI® flow sensing technology which is optimized for medical applications where accuracy and reliability are key requirements.

The **Certifier™ Plus** and **Certifier™ Pro** offer a familiar user interface that is simple and easy to use with a compact and durable instrument design. Certifier Flow Analyzers are the go-to tool for manufacturers and biomedical professionals to efficiently test and service respiratory medical equipment.

The Certifier™ Pro Flow Analyzer is a benchtop test system that combines high and low flow, pressure, temperature, and oxygen concentration measurements in an all-in-one flow analyzer.

The Certifier™ Plus Flow Analyzer is a handheld test system with a compact and lightweight design. This portable instrument operates up to 8 hours continuously on battery power and can be mounted to a ventilator or workbench.



### Key Features and Benefits:

- ◆ Color touchscreen displays up to 18 parameters
- ◆ Real-time graphing mode
- ◆ High flow accuracy- temperature and pressure compensated
- ◆ Intuitive user interface is simple to operate
- ◆ Automatic breath detection
- ◆ User configurations, transfer between Certifier™ instruments
- ◆ AC power and rechargeable battery operation
- ◆ Save data and screenshots



### Measure 28 Different Test Parameters:

- ◆ Flow rate
- ◆ Peak & minimum flow
- ◆ Volume (inhaled and exhaled)
- ◆ Minute volume
- ◆ Low pressure (Differential)
- ◆ Peak, PEEP and plateau pressures
- ◆ Mean and minimum airway pressures
- ◆ High pressure
- ◆ Barometric pressure
- ◆ Static compliance
- ◆ Inspiratory, inspiratory pause and inspiratory rise times
- ◆ Expiratory times
- ◆ I:E ratios
- ◆ Respiratory rate
- ◆ Gas temperature
- ◆ Oxygen concentration



# CERTIFIER™ PLUS MODEL 4080-F

## TSI Certifier™ Flow Analyzers



Item Number	Description	Replacement Part Number	Qty
1-10, 12-13,15	Certifier Plus High Flow Test System, Standard Kit	13 of 15 Standard Kit Components	*
20	Certifier Oxygen Sensor Kit	4073	1
24	RAM Mounting Kit for Interface + Flow Module	130399	1
29	Adapter, 22mm F to 22 mm F, Straight	130373	1
30	Adapter, 15 mm M to 22 mm F, Pediatric Cuff	130374	1
31	Carrying Case, Certifier Plus, Fitted (replaces carrying case from the standard kit, item 1)	130393	1
32	Test Lung, Adult 1.0L	130396	1
33	Stylus, Capacitive Touch	130370	1

### Notice

The Module 4080-F test kit is designed to include everything needed to test the pneumatics of mechanical ventilators. For expanded applications, such as testing anesthesia workstations, the model 4082 Low Flow Module Kit can be added.



## Certifier™ Pro Flow Analyzer Test System



The Certifier™ Pro Flow Analyzer is a benchtop test system that combines high and low flow, pressure, temperature, and oxygen concentration measurements in an all-in-one flow analyzer. The Certifier™ Pro precisely measures high and low flows with an accuracy of 1.75% of reading throughout the entire flow range.

The Certifier Pro touchscreen display is mounted at an angle for easy operation and data viewing. The instrument can be operated on battery power, and users can power down flow channels when not in use to extend battery operation.

The Certifier Pro can measure air, oxygen, carbon dioxide, nitrogen, and nitrous oxide gas flows. This full-featured test instrument can be used to test most types of ventilators and anesthesia gas delivery machines as well as a variety of other respiratory medical devices.

### Certifier™ Pro Instrument Kit includes:

Material Description	Part Number
Certifier Pro Flow Analyzer	4090
<b>High Flow Inlet Filter, 22 mm x 22 mm M/F, HEPA</b>	<b>1602341</b>
Low Flow Inlet Filter, 1/4 inch, HEPA, plus tubing	1602317
<b>Adapter, high pressure port</b>	<b>1611221</b>
Adapter, 22 mm x 6 mm, qty 2 (to connect to Low Flow Filter to high flow channel using 130373 F/F adapter)	1102091
<b>Adapter, 15 mm ID x 22 mm OD</b>	<b>1102093</b>
Adapter, 22mm F to 22mm F, Straight	130373
<b>Adapter, 15mm M to 22mm F, Pediatric cuff</b>	<b>130374</b>
Airway pressure fitting with screen	1611330
<b>Pressure tubing, silicone, 1/8-inch ID x 1/4-inch OD x 48 in.</b>	<b>3002053</b>
Power supply 100/240 VAC to +12 VDC 2.1 mm plug, includes plug set with NA, UK, EU, CN, SAA connectors	130400
<b>Oxygen sensor cell (installed)</b>	<b>130377</b>
Battery, 4 cell Lithium-Ion 7.2 V 6.4 Ahr (installed)	130385
<b>Hanging Clip (to hang the instrument from a ventilator rail)</b>	<b>130375</b>
Optional Carrying Case	
- Fitted for the Certifier Pro, dimensions 19 x 14.75 x 6.5 inches	130378
- Hard outer shell and foam protection	



## In Alphabetical Order

Absolute Pressure Meters.....	153	MSP-2100.....	140
Accessories, Biomedical.....	146	Multimeters.....	138
Anesthesia Test Equip.....	107-111	Multi-Parameter Sims.....	139,143
Anesthetic Agent Analyzer.....	107	NIBP.....	139
Balometer.....	119	NIBP Adapter/Fitting Kit ....	139, 146
Battery Eliminators.....	145	Nitrous Oxide Monitors.....	118,119
Biomed Test Equip.....	114-115	Noise Dosimeters .....	115
Blood Pressure Cables.....	147-149	Non-Ferrous Tools .....	130
Bluetooth Adapters.....	14	Oscilloscopes .....	142
Cables.....	145-149	Oxygen Analyzers.....	141
Cardiac Output Sims .....	139,143	Oxygen Lube Thread Sealant.....	124
Carts .....	116	Oxygen Monitors.....	141
CO <sub>2</sub> /CO Monitors .....	118	Oxygen Sensors.....	141
Comparison Chart (AA) .....	79-80	Pacemaker Tester.....	117
Comparison Chart (ESU).....	82	Particulate Filters.....	123
Comparison Chart (IPA).....	83	Patient Sims.....	143
Comparison Chart (NIBP).....	81	Pearson CT.....	122
Current Source.....	155	Power Cord Options.....	144
Defibrillator Analyzers.....	117	Pressure Gauges.....	125,153
Dew Point Meters.....	123	Pressure Meter.....	150-153
CQM.....	122	Pressure Meter Adapter Kits.....	107
Digital Multimeters.....	138	Pulse Oximetry Sims.....	140
Digital Pressure Meters.....	150-153	Resistors, Load.....	122
Digital Thermometers .....	156	Respiratory Test Equip.....	108-111
ECG Sims & Access.....	143	Safety Analyzer Cables.....	146,155
Environmental.....	118-119	Safety Analyzers.....	154-155
ESU Analyzers & Access.....	120-122	Safety Analyzer Protective Boot..	155
FingerSim.....	140	Simulators, Patient.....	143
Flow Analyzer.....	108-111	Smart Manometer .....	152-153
Flowhoods.....	119	Snoop Leak Detector .....	125
Flowmeters .....	111,124	Sound Level Meters .....	115
General Information.. ..	106	SpO <sub>2</sub> .....	140
Gas Analyzers.....	108-111	SPO-2000.....	140
Gauges.....	125,153	Stopwatches.....	115
Hand Pumps (Pressure/Vac).....	125	Tachometers .....	114
HEPA Vacuums.....	116	TEE Leakage Tester.....	157
HVAC .....	119	Temperature .....	156
Imaging.....	126-136	Temperature Adapters .....	156
Infusion Pump Analyzers.....	137	Test Lead Sets .....	156
Intl. Safety Analyzer.....	155	Test Lungs.....	109
Invasive Blood Pressure.....	143	Thermo-Anemometers .....	119
Kelvin & Chassis Cables ....	146, 155	Thermometers.....	156
Leak Detectors.....	125	Ultrasonic Leak Detectors .....	115
Light Meters.....	114	Ultrasound Phantom.....	126
Low Pressure Warning Devices....	125	Ultrasound Leak Tester.....	157
Lung Sims.....	109	Ultrasound Watt Meters.....	159-161
Mass Flowmeters.....	111	Vacuums, Service.....	116
Medical Gas.....	109	Ventilator Analyzers.....	108-111
Medical Gas Fitting Kits.....	123	Weights.....	115

## Manufacturer Names Below

ACS.....	119
AG Instruments.....	85-86, 124
Alnor.....	119
Ampco.....	130
Analytical Industries, Inc.....	141
Ansonics.....	125
Atrix Vacuum .....	116
Bacharach .....	118
BC Group.....	various
CDI .....	116
Diagnomatic by Pro-Project.....	126-129
Exttech.....	114, 115, 119,138,156
Fluke®.....	138,156
Gelman .....	123
Imprex.....	130
IMT Analytics.....	108-109
Jensen Tools.....	115
Krytox.....	111
Magnum .....	125
Matheson .....	123
Maxtec .....	141
Meriam .....	125, 152-153
Netech.....	117
Ohmic.....	93-96, 123, 160-161
Ohmeda.....	107, 111, 123
Pearson.....	122
Pro-Project.....	126-129
Remin.....	116
Riken.....	111
Rice Lake.....	115
RTI.....	97-100, 131-136
TSI.....	104-104, 110-111
UMA.....	159
Viasensor.....	118,124
Vishay-Dale.....	122
WIKA.....	125



[BCGroupStore.com](http://BCGroupStore.com)

Any of the trademarks, service marks or similar rights that are mentioned, used or cited within are the property of their respective owners. Their use here does not imply endorsement or affiliation with any of the holders of any such rights.

## BC Biomedical Products

BC Biomedical products will ensure you receive high quality products at minimal cost. The first half of this catalog is dedicated to the BC Biomedical Products, with full specifications and detailed model information. Please call or email us so we can provide you more information and comparisons to what you are currently using.



## HOW TO CONTACT US

Toll-Free:  
1-800-242-8428

Local & International:  
1-314-638-3800

Fax:  
1-314-638-3200

Hours:  
8:00 am to 5:00 pm CST

Address:  
BC Group International, Inc.  
3081 Elm Point Industrial Dr.  
St. Charles, MO 63301 USA

Dealer Inquiries:  
sales@bcgroupintl.com

E-Mail:  
sales@bcgroupintl.com  
service@bcgroupintl.com

BC Marketplace Online  
[BCGroupStore.com](http://BCGroupStore.com)

### Customer Satisfaction & Feedback

We strive for 100% Customer Satisfaction. Your feedback is very important to us & we take each comment seriously. Many of our improvements have been implemented due to recommendations from customers. After each sales or service transaction, please take a moment to complete a Customer Satisfaction survey found in your product shipment paperwork.

*Please contact us at any time if we fail to meet your expectations.*

### Pricing Notes

We try to ensure that prices are up-to-date as of printing date but it isn't always possible. For up-to-date pricing, contact us or visit our online store. All prices are in U.S. dollars (USD); International Pricing can be determined by adding 20% to the item's listed price.

ISO 13485:2016  
Certified  
ISO 9001:2015  
Certified  
ISO/IEC 17025:2017  
Accredited

PLEASE NOTE:  
Pricing and Specifications may  
change without notice.  
SF-SLS-180 (BD)

© BC Group International Inc. 2023

Be sure to check out what is new  
from the BC Marketplace:



**IPA-3100**  
**Single Channel**  
**Infusion Pump Analyzer**  
**Page 137**



**ESU-2350**  
**Mid-Range**  
**Electrochemical Analyzer**  
**Page 121**



**SA-2600**  
**Safety Analyzer**  
**Page 154**



**SA-2000 Series**  
**Protective Boot**  
**Page 154**

## Doing Business with BC Group

*We make it easy*

*Here are the ways to order products and services from us:*

- **Buy Online:** Safe, secure internet shopping at [www.bcgroupestore.com](http://www.bcgroupestore.com)
- **Credit Card:** MasterCard, Visa, American Express and Discover (Domestic Only) International with prior approval only. **Service charge may apply.**
- **IMPAC Card:** U.S. Government Purchasing Card
- **C.O.D.:** Cash on Delivery (Money order or Cashier's Check only)
- **C.I.A.:** Cash/Payment in Advance
- **Net 30 Day Terms:** Please contact one of our sales team members if you're interested in this program
- **Wire Transfer:** Electronic Payment (\$50 USD additional bank charge added to total amount.)
- **Signature Required:** Our default shipping method is signature required. We must receive authorization in writing to ship without signature.
- **Handling Fee:** Handling fees will apply, when shipping on third party shipping account
- **Blanket Purchase Order:** A BPO for a year or more saves time and administrative costs for your organization
- **Biomedical Teaching Institution Discount Program:** Contact us for more information concerning this program
- **Major Account Programs:** Special incentives and support for larger customers, covering both product purchases and test equipment service. We can custom-design a program for you, covering everything from "new-hire" test equipment/tool assortments to complete management of your calibration program. If you're a large ISO, a manufacturer or have multiple sites, be sure to inquire.
- **Faxed-in Orders:** Upon completing our sales order form, located at [BCGroupStore.com](http://BCGroupStore.com), feel free to fax it to us at 1-314-638-3200 to ensure prompt processing.
- **Authorized Dealers:** Check [BCGroupStore.com](http://BCGroupStore.com) for list of dealers.

PLEASE NOTE:

*Minimum order with BC Group is \$50 domestic, \$250 international.*



J



### BC Biomedical Anesthetic Agent Analyzer Series

I. AA-8100 ..... **\$4961**

The AA-8100 is an enhanced version of the AA-8000, adding Auto Agent ID, Bluetooth, iOS and Android Apps, CO2 Gas Analysis and 100 DUT Tags - downloadable from a PC, tablet or smartphone. Designed to meet the demand for an advanced, small, easy to use unit with high reliability and accuracy it utilizes proprietary state-of-the-art digital NDIR (Non-Dispersive Infrared) Technology.

- Auto Agent ID
- Bluetooth
- iOS and Android Apps (myBC mobile) \*Mobile Device Not Included

← **For more info on this product - Pages 11-12** →

J. AA-8000..... **\$3650**

The AA-8000 is the latest in portable anesthetic agent analyzers. It was designed to meet the demand for a small, easy to use unit with high reliability and accuracy. Utilizing proprietary state-of-the-art digital NDIR (Non-Dispersive Infrared) Technology it provides a low cost, high function, microprocessor-based analyzer that is simple to operate while maintaining high performance and accuracy.

- State-of-the-art NDIR (Non-Dispersive Infrared) Technology
- Measures 4 Anesthetic Agent Gases: Sevoflurane, Isoflurane, Desflurane and Halothane

← **For more info on this product - Pages 9-10** →

### Anesthesia Pressure Meter Adapter Kits

- Easily connect a pressure meter to popular anesthesia machines.  
**BC20-40600** Ohmeda® High Pressure Kit.....**\$251**
- For testing: Model I & II Secondary Regulator, Excel Secondary Regulator, 7000 Vent Primary Regulator, Modulus CD & Mod II Plus Primary & Secondary and 78XX Primary Regulator  
**BC20-40601** Ohmeda® Low Pressure and Drager Combo Kit .....**\$239**

### Optional Accessories:

- **10-02** CPC Coupler 1/8" MNPT.....**\$17**
- **22-02** CPC Connector 1/8" Barb.....**\$14**

**SCAN the QR code below to view our how to video about the AA-8000 series**

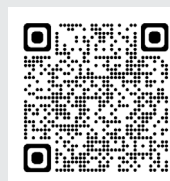

### A. PFC-3000 FLOW ANALYZER (BENCHTOP) SERIES

The PFC-3000 series of instruments measure flow, pressure, temperature, humidity and O<sub>2</sub> concentrations bidirectionally. The one-of-a-kind Adult, Pediatric and High Frequency ventilation measuring modes make the PFC-3000 the ideal calibration tool for all ventilators, anesthesia machines and spirometers.

- PFC-3000A** Basic Flow Analyzer.....\$8280
- PFC-3000L** Basic Flow Analyzer with additional low pressure sensor.....\$8920
- PFC-3000V** Basic Flow Analyzer with additional vacuum sensor for vacuum measurements.....\$8920

#### Optional Accessories:

- FlowLab Software** Software for PFC-3000 Series.....\$450
- B. MGA-3050** Multi Gas Analyzer.....\$5775

← [For more info on this product - Pages 27-28](#) →

### C. Citrex H5 Mobile Gas Flow Analyzer.....\$7700

The CITREX H5 Ventilator Analyzer offers the most advanced user interface for demanding applications on a high resolution 4.3 inch multi-touch screen. It is portable, precise and users can customize the measurement screens to suit their specific needs.

The CITREX H5 is designed to support a variety of daily applications. Thanks to its precision and reliability, you can use the CITREX H5 to test a wide range of medical devices, such as respiratory and anesthesia devices, flow meters, pressure gauges, suction devices, Oxygen concentrators, etc.

The H5 includes auto-sequence apps for several popular ventilators that simplifies the PM process and saves test results. The MGA-3050 Multi-gas Analyzer can now be used with the H5 to measure vaporizer output concentrations for all common anesthetic agents.

### D. Citrex H4 Mobile Gas Flow Analyzer.....\$5680

The CITREX H4 gas flow analyzer is designed for mobile and easy use while still meeting all requirements of day-to-day field operations. Its capabilities allows it to analyze the performance of a wide variety of medical devices. Examples of gas flow or pressure producing devices are: respiratory ventilators, endoscopic insufflators, anesthetic machines, oxygen flow meters, pressure gauges and suction devices.

### E. Citrex H3 Economical Gas Flow Analyzer.....\$3130

The CITREX H3 provides the necessary functions required to test and validate the performance of respiratory ventilators. Its compact and lightweight design make the CITREX H3 a small and powerful tool. A single integrated flow channel measures pressure, flow, volume and oxygen concentration. The capability to calculate ventilation parameters makes CITREX H3 the ideal device to verify the performance of a wide range of respiratory devices.



G



H



I



J



K



**G. IMT Analytics Flow Analyzer PF-300 PRO.....\$11300**  
FlowAnalyzer PF-300 PRO test set combines PF-300 PRO with comprehensive accessories suitable for calibration and verification of all ventilators.

Scope of delivery: FlowAnalyser PF-300 PRO, MultiGasAnalyzer, SmartLung 2000, FlowLab Software incl Activation code, carrying case, user manual (download link), USB cable, power supply, adapter-set, protection filter

The PF 300 PRO is the upgraded model of the PF 300, which now includes (A) Basic Flow Analyzer, (L) Flow Analyzer with Low Pressure Sensor and (V) Flow Analyzer with Vacuum Sensor.

The PFC-300 PRO features Automatic Breath Detection, Highest Flow Accuracy, Ultra-Low Flow Measurement, Fast Sampling Rate of 1000 Hz, Pressure & Vacuum Measurements, Low Differential Pressure Measurement, High Resolution Multi-touch Display, Lightweight Portability, 16-Hour Battery Life and Integrated Apps with Guided Test Sequences.

Airway resistance, lung compliance & leakage widely adjustable.

**Optional Accessories:**

**H. MGA-3050 Multi Gas Analyzer.....\$5775**

**I. BC Biomedical Lung Simulator Series**

**LS-1000E EasyLungSimulator.....\$225**

- Unique Double-conus Connector (OD 22 conical, OD 15 conical)
- Unbeatable Simplicity & Price

**LS-2000A Adult Lung Simulator.....\$900**

**LS-2000I Infant Lung Simulator.....\$900**

- Adjustable Compliance Settings
- Adjustable Resistance Settings
- Variable Leakage Valves
- Simple Design
- Fraction of the Price and Size of any Comparable Lung Sim

← **For more info on this product - Pages 39-40** →

**J. IMT Analytics SmartLung SL-2000-2L.....\$756**

The SmartLung 2000 2L simulates the lung of adults and is the only test lung which covers settings according to standards IEC 60601-2-12, IEC 60601-2-13 and EN 794-3.

**BC Biomedical TestLung Infant LS-1000M**

The TestLung Infant is the ideal tool to test neonatal and infant ventilators.

**K. LS-1000M TestLung Infant.....\$160**

- Volume 20 mL @ PEEP = 0mbar; P<sub>Insp</sub> = 30 mbar
- Compliance 0.7 mL/mbar @V<sub>t</sub> 20 mL
- Dimensions 45 mm × 150 mm
- Weight 25 g
- Material Silicone

← **For more info on this product - Pages 39-40** →

**Test Lungs**

**10107 Infant.....\$151**  
**BC20-40200 Adult.....\$170**

L



**Model 4090**



**Certifier™ Pro Flow Analyzer Test System**

M



**Model 4089**



**Complete 4080-F Test Kit**

**L. TSI Certifier™ PRO Flow Analyzer Test System.....\$8300**

The Certifier ProFlow Analyzer is a benchtop test system that combines high and low flow, pressure, temperature, and oxygen concentration measurements in an all-in-one flow analyzer. The Certifier Pro precisely measures high and low flows with an accuracy of 1.75% of reading throughout the entire flow range.

The touchscreen display is mounted at an angle for easy operation and data viewing. The instrument can be operated on battery power, and users can power down flow channels when not in use to extend battery operation.

Includes Certifier Pro Flow Analyzer (Model 4090), High Flow Inlet **Filter**, 22mm x 22mm M/F, HEPA, Low Flow Inlet **Filter**, 1/4 inch, HEPA, plus tubing, **Adapter**, high pressure port, **Adapter**, 22 mm x 6 mm (to connect Low Flow Filter to high flow channel using 130373 F/F Adapter), **Adapter**, 15 mm ID x 22 mm OD, **Adapter** 22 mm F to 22 mm F, Straight, **Adapter**, 15 mm M to 22 mm F, Pediatric cuff, **Airway pressure fitting** with screen, **Pressure tubing**, silicone, 1/8-inch ID x 1/4-inch OD x 48 in., **Power supply** 100/240 VAC to +12 VDC 2.11 mm plug, includes plug set with NA, UK, EU, CN, SAA connectors, **Oxygen sensor** cell (installed), **Battery**, 4 cell Lithium-Ion 7.2 V 6.4 Ahr (installed) and **Hanging Clip** (to hang the instrument from ventilator rail)

**TSI Certifier™PLUS® High Flow Vent Test System**

**4080-S.....\$5610**

**Includes** Controller Module (Model 4088) and High Flow Module (Model 4081) AC adapter, bacteria filter, pressure tubing and adapters, operator's manual, National Laboratory traceable Certificate of Calibration and soft-sided carrying case.

- Color touch screen graphical user interface
- Graph mode Supports Adult, pediatric, anesthesia, Neonatal & high frequency ventilators
- Bi-directional & unidirectional gas flow capabilities
- Print & data storage - 1 MB of internal storage & 64 MB optional SD flash card
- Volumes & flow in BTPS, BTPD, Actual, Standard or user defined standard
- Calibrations for Air, Oxygen, Air/Oxygen mixture, nitrogen, Nitrous Oxide (low flow module only) & carbon dioxide
- High pressure port – to 150 PSIG
- Rates up to 1500 BPM

**Optional Accessories:**

- **4082** Low Flow Module.....**\$1060**
- **4073** Oxygen Sensor Kit: Adds O2 measurement capability to Certifier FA® Test System.....**\$375**
- **1303860** Printer Cable.....**\$65**
- **1208061** Extra Battery Pack/Charger Kit.....**\$160**

**4080-F.....\$6895**

**The Certifier™ Plus Test System 4080-F** is made up of a Certifier™ Plus High-Flow Module Kit 4081, Certifier™ Plus Interface Module Kit 4089, and an Oxygen Sensor Kit 4073.

This multi-function pneumatic test system can measure 28 different test parameters and graph data in real-time. Pressure and temperature compensated bi-directional flow sensors deliver high accuracy gas flow measurements with a fast rate of response and industry-leading, low-pressure drop. Users can measure using STP, ATP, BTPS, BTPD, or user-defined gas conditions and test breath rates up to 1500 bpm.

**4080-F Test Parameters**

- Flow Rate, Peak Flow, and Minimum Flow
- Inhaled and Exhaled Tidal Volumes, Minute Volume
- Low Pressure (Differential)
- Peak, PEEP, and Minimum Pressures

### A. TSI General Purpose Mass Flowmeters

- Flow rate, volume, temperature, pressure in one instrument
- High accuracy - 2% of reading
- Multi-gas, user selectable
- Built-in temperature & pressure sensors for high accuracy without external compensation
- Standard L/minute or Volumetric L/minute
- RS-232 & Analog outputs

**B. 4040 Mass Flowmeter** The TSI Mass Flowmeter 4040 can be used for a multitude of gas flow measurement applications. Whether measuring gas flows in a laboratory or manufacturing setting, TSI general-purpose mass flowmeters provide accurate results with multiple data output options. The display versions come complete with accessories making setup and operation fast and convenient.....**\$1355**

**C. 4043 Mass Flowmeter** 0-200 LPM range.....**\$1355**

- User selectable Gas calibration (Includes: Air, N<sub>2</sub>, O<sub>2</sub>, Air/O<sub>2</sub> Mix; Flow up to 300L/min & 22 mm ISO tapered O.D. inlet/outlet size)

**D. 4140 Mass Flowmeter** The TSI Mass Flowmeter 4140 (0.01-20L/min Air, O<sub>2</sub>, N<sub>2</sub> 1/4" tube) can be used for a multitude of gas flow measurement applications. Whether measuring gas flows in a laboratory or manufacturing setting, TSI general-purpose mass flowmeters provide accurate results with multiple data output options. The display versions come complete with accessories making setup and operation fast and convenient.....**\$1285**

**4143 Mass Flowmeter** 0-20 LPM with 3/8" connection...**\$1285**

- User selectable Gas calibration (Includes: Air, N<sub>2</sub>, O<sub>2</sub>; Flow range up to 20 L/min & 0.25 in O.D. inlet/outlet size)

**41403 Mass Flowmeter** Same as 4140 but adds N<sub>2</sub>O...**\$1375**

**41433 Mass Flowmeter** 0-20 Same as 41403 but has 3/8" connection.....**\$1375**

#### Optional Accessories:

- **4199 Flowmeter Battery Pack Base**.....**\$165**

**E. BC78XX TestBox (Ohmeda®)**.....**\$386**

Test box simplifies testing of Ohmeda® anesthesia ventilators. Includes a 24" connecting cable.

#### Optional Accessory:

- **BC78XX-CABLE** Replacement 24" cable (also fits Ohmeda® 78XX test box model).....**\$82**

### Special Tools for Anesthesia

**F. 10195K29 Krytox® Oxygen-compatible Lubricant** (one tube).....**\$125**

**G. Riken FI-8000P Portable Gas Indicator**.....**\$3683**

This Anesthetic Gas Indicator measures vaporizer output concentration using a digital display and does not require correction factors. Measures concentration in percentage for Desflurane (Suprane), Sevoflurane, Isoflurane (Forane) and Halothane. The battery operated FI-8000P allows the user to select the carrier gas (O<sub>2</sub> or Air) and has an internal pump. Includes: Sampling Tube and Sampling "T" Piece.

**GE Anesthesia Fitting Kit**.....**\$297**

Recommended model for use with GE Aestivas, Aespires, Avance, Aisys, Avance CS2, Aisys CS2 and CS600 anesthesia machines. Certain tubes are also applicable to the Engstrom Ventilator (Red, Yellow, Green and Black). The DPM-235175NNFC Digital Pressure Meter is the recommended pressure meter for use with the kit for testing these systems.



A

B



Pictured with optional 4199

C



D



Pictured with optional 4199

E



F



G





## Meriam Autoclave Analyzer

The Meriam Autoclave Analyzer AA100 is a first of its kind diagnostic tool that provides real time measurements from an autoclave during a sterilization cycle. The analyzer will speed up repair time, streamline preventative maintenance and help with the training of new biomedical technicians.

With 4 RTD temperature inputs and 2 pressure inputs the Autoclave Analyzer captures all the measurements as they are happening during the autoclave run cycle.

The AA100 data is highly accurate, NIST traceable, and time synchronized. Data logging, exportable test logs, several user configurable inputs and multiple engineering units make this an asset to all biomedical service technicians working with steam sterilization.

## Definable Measurement Solutions

- The autoclave analyzer provides you with a specialized service tool for maintenance and calibration of steam sterilizers.
- With multiple measurement solutions in one device, you can be more efficient as you diagnose the system.
- Built on a foundation of measurements traceable to NIST, Meriam is able to combine temperature and pressure measurement instruments in a single enclosure.
- Use as a mobile technician tool
- Real time monitoring of a steam sterilization cycle.

## Use Cases

- Medical device technicians tool
- Integrated digital measurements platform
- Autoclave preventative maintenance
- Trouble shooting
- Performance Confirmation & reporting
- Training Tool

## Product Warranty

Warranty Components of this system are warranted under use against any and all manufacturing defects from the listed date of manufacture for six (6) years.

Other components are covered by their manufacturers' warranties. Any failure resulting from defective parts or faulty workmanship, as determined during evaluation by the manufacturer, will be repaired under warranty.

This warranty will be null and void for any unit that has been subject to misuse, negligence, accident, or repairs other than those performed by an approved affiliate of Western / Scott Fetzer Co.



Autoclave Analyzer

## Benefits

- Specialized service tool for maintenance and calibration of steam sterilizers
- One device with correlated independent measurements to verify the function of your sterilizer
- Reduce diagnostic and service time
- NIST traceable measurements
- 3 operation modes: Live, Record, and Review
- All data logs are date time stamped
- PDF or Excel (.txt file) report generation
- Long term storage of previous test(s)
- Live graph as the test is running
- Each measurement is displayed in a unique color
- Pan and zoom (in Review & Test mode)
- Hide/show measurements on graph
- Additional time stamped notes section
- User selectable measurement units

System Information ▪ Device Application Revision ▪ Sensor Firmware ▪ Serial Number ▪ Model Name

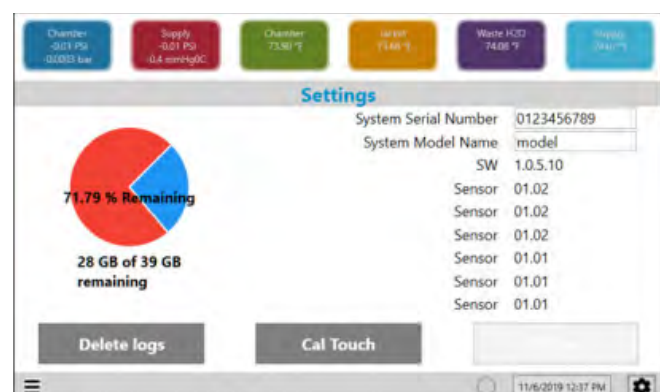



## Specifications

### Pressure measurement

- Two 100 psi compound Isolated sensors
- -14.5 psi to 100 psi
- Accuracy Specification  $\pm$  (0.02% of reading and 0.050% of full scale)

### Temperature measurement

- Four Class A PT100 RTDs
- Tolerance =  $\pm(0.15 + 0.002 |t|)$  °C

### Temperature specification:

- Operating range: 41° F - 104° F (5° C - 40° C)
- Storage range: -32° F - 140° F (-35° C to 60° C)

### Connections:

- 1/8" Female NPT 316SS
- USB - to export data
- 12 V DC wall adaptor with locking power cord
- Dimensions: 12.5" L x 9" W x 3.9" D
- Weight: Device - 9 lbs; in carrying case - 12 lbs.

For product manual and more details,  
scan the code below to visit the  
Autoclave Analyzer on our webstore.



## Product Options

Autoclave Analyzer Unit, Part Number AA100 includes:

- 10.2" touch-panel computer
- Four RTD temperature sensor ports
- Two compound isolated 100 psi pressure ports
- Wireless keyboard and mouse
- Soft-sided carrying case

Autoclave Accessories Kit, Part number AA101 includes:

- Four 3.3m 4 pin M12-F A coded cables
- Four Class A RTD M12 A coded probe connectors
- Two 3m FVCO-FVCO 100 psi minimum rated steam pressure hoses
- Four 1/8" MNPT to MVCO pressure fittings

AA100 Autoclave Analyzer .....\$5500

AA101 Autoclave Accessory Kit .....\$1150

### NIST Certificate

- NIST certificate with data for each sensor will be included with all orders.
- Pressure Accuracy:  $\pm$  0.02% of reading & 0.050% of full-scale
- Temperature Accuracy: Tolerance =  $\pm$  (0.15 + 0.002|t|) ° C

J



J. Extech 401025 Visible Light Meter .....\$275  
 0 to 5000 Fc & 0 to 50,000 Lux, digital, handheld, ± 5% Accuracy.  
 • NIST Traceable Calibration Certificate Included

K



K. Extech EA30 EasyView Light Meter .....\$325  
 • Widest range to 40,000 Fc/ 400,000 Lux is ideal for outdoor applications  
 • Utilizes precision silicon photodiode sensor  
 • Complete with a built-in stand, remote sensor with a protective cover, protective rubber holster, a five foot coiled cable for easy storage & six AAA batteries  
 • NIST Traceable Calibration Certificate Included

### Tachometers

L



L. **BC Biomedical TC-1726C** Combo Photo/Contact Tachometer with NIST Traceable Calibration Certificate .....\$556

← For more info on this product - Pages 66-70 →

### Replacement & Optional Accessories:

- **BC20-00601** Carrying case.....\$72
- **BC20-00602** 12 inch surface speed wheel.....\$108
- **BC20-00603** Convex rubber tip with metal hub.....\$36
- **BC20-00604** 10 cm surface speed wheel.....\$25
- **BC20-00605** Concave rubber tip with metal hub.....\$35
- **BC20-00608** Contact adapter assembly.....\$88
- **BC20-40705** Phototach Reflective Strip Material.....\$21

M



M. Extech 461893 Photo Tachometer.....\$320  
 Extech 461895 Combo Photo/Contact Tachometer...\$380  
 Extech 461995 Laser Combo Photo/Contact Tachometer .....\$420



@BCGroup1988



@BCGroupIntl



BCGroupStore



@BCGroupIntl



company/bc-group-international-inc



**Extech 407766 Sound Level Calibrator .....\$556**  
94 dB & 114 dB Levels @ 1 kHz.  
• NIST Traceable Calibration Certificate Included

**A. Rice Lake Precision Weights & Weight Sets (Class F)**

Precision Laboratory Stainless Steel Weight Sets for testing analytical balances and digital scales.

Cast Iron Grip Handle Weights for Testing Patient Scales

Part #	Weight	Not Cal'd	w/NIST
12823	5 lb	\$ 63	\$143
12828	10 lb	\$ 82	\$162
12870	20 lb	\$105	\$185
12833	25 lb	\$124	\$204
12839	50 lb	\$141	\$221
12862	100 lb	\$595	\$700

Precision Weight Sets

12518	1 g to 1 kg Set	\$500	\$850
12524	1 g to 2 kg Set	\$580	\$975

*Other weights available, please call us with your needs!!*

Sales tax is charged in all states except AK, DE, HI, IL, IN, MO, MT, NH, OR, TX.

If your "Ship to" state does not match any of the states listed and you are tax exempt, the customer needs a tax-exempt certificate for the "Ship to" name and ship to state.

With **National Institute of Standards & Technology (NIST)** Certification, the individual weight or weight set is automatically assigned a serial number.

**B. Extech HW30 Humidity/Thermometer Stopwatch.....\$121**  
Digital UP/DOWN timer displays Temperature, Humidity and Heat Index.

- NIST Traceable Calibration Certificate Included (Time function only)

**C. Jensen JTK-75-WIM.....Call for Pricing**

The JTK-75RL Features a 7" deep black, Monaco style case The corners are extra thick. Combination lock, flip key latches and a padded handle. Contains inch tools only.

**D. Jensen JTK-7500-DBL.....Call for Pricing**

JTK-7500DBL is a double-sided case which contains the same tools as the JTK-7500 plus a third pallet filled with metric tools (#11) and a portfolio pallet (#8). The double-sided case has two individual tool compartments and also features three outside pockets. D-ring attached for optional shoulder strap.





**E. Omega Supreme Electronic Vacuum**

- ESD-Safe
- EMI/RFI line filtered
- Accessories store inside lid
- 0.3 Micron Filter
- Size / Weight: 19"x 8"x10" / 11 Lbs

**VACOMEGASLFH 110 V with HEPA.....\$350**

**Optional Accessories:**

- **31700-2P** 0.3 Micron Cap. Std. Filter (two pack).....**\$30**
- **VACPACK** Deluxe Back Pack.....**\$129**

**F. HEPA Express Vacuum VACEXP-04 .....\$219**

- Safe for electronics, EMI/RFI Filtered
- HEPA grade filtration in a small powerful size

**Optional Accessories:**

- **710333** 0.3 Micron Cap. Std. Toner Filter (two pack).....**\$26**
- **730333** 0.12 Micron Cap. HEPA Filter (two pack )....**\$45**

**G. Field Portable Static Kit ATIESD-1CPGS.....\$54**

- Includes mat, wrist strap & ground cord.

**H. CDI 10002MRMH ADJ. TORQUE WRENCHES 10-100 ft. lbs.....\$272**

- Metal Handle Dual Scale. The metal handle series offers the user a rugged, industrial strength torque wrench able to withstand the rigors of professional use. Handles are lightly knurled for a tough, non-slip grip. Individually serialized with matching certificate of calibration traceable to N.I.S.T.

**I. CDI KL45-401SM ADJ. SCREWDRIVER 5-40 Inch/Pound ...\$337**

- Adjustable models offer versatility for applications that require more than one torque value. A simple, cam-over design prevents over-tightening and possible damage to components. Individually serialized with matching certificate of calibration traceable to N.I.S.T.

**Complete CDI Torque Product Line .....Call**

**Remin Kart-A-Bag Carts**

- Ten Year Limited Warranty
- Solid chrome-plated steel with heavy-duty wheels
- Captive elastic cord to secure load
- Durable & heavy-duty

**J. Remin Super 600.....\$252**

- 6" roller-bearing semi-pneumatic wheels
- 300 Lbs capacity

**K. Remin TriKart 800.....\$315**

- 6" roller-bearing semi-pneumatic wheels
- 300 Lbs capacity
- Tilt-back swivel casters

**Other models, sizes and capacities are available.  
Call for specs and prices!**

## BC Biomedical Defibrillator Analyzer Series

A. DA-2006.....\$3455

**As of 3/2023 now manufactured with built-in Bluetooth.**

A defibrillator analyzer developed for testing all external defibrillators. The unit may operate as a powerful stand alone device or may be incorporated into an automated PC-based and remotely controlled device. Includes: user manual, internal paddle adapters, protective plates and battery eliminator.

B. DA-2006P.....\$5916

**As of 3/2023 now manufactured with built-in Bluetooth.**

A precision instrument for testing defibrillators and external (transcutaneous) pacemakers. The built-in test procedures and extensive resistance loads for pacer testing make the DA-2006P a versatile test instrument and solid value. Includes: user manual, internal paddle adapters, protective plates and battery eliminator.

### Optional Accessories:

- BC20-00427 Plastic Protective Plates (Set Included) \$33
- BC20-00432 Internal Paddle Adapters (Set Included) \$65
- BC20-41341 Communication Cable(DB9).....\$154
- BC20-41339 Communication Cable Adapter(USB).\$154
- BC20-30108 Soft Carrying Case.....\$144
- BC20-41401 Bluetooth Adapter (Legacy).....\$99

← For more info on this series - Pages 15-18 →

C. DA-2006-VL.....\$3091

DA-2006-VL, works in conjunction with our DA-2006 Series Defibrillator Analyzers, providing Variable Loads used when testing Defibrillators to assure the proper electrical current is delivered to the heart, per IEC 60601-2-4 and AAMI DF80 standards.

### Defib & Pace Adapters (for DA-2006 & DA-2006P)

- D. BC20-00420 PhysioControl - Defib/Pace.....\$197  
 BC20-00423 Cable, Defib/Pacer Zoll.....\$197  
 BC20-00426 Cable, Defib/Pacer HP/Agilent (Old Style barrel connector).....\$197  
 BC20-00433 Cable, Defib/Pacer Test Philips (New Style).. \$197  
 BC20-00434 Cable, Defib/Pacer Test Cardiac Science.\$197  
 BC20-00435 Defib Test Cable, Zoll AED Plus .....\$238

### E. EXPMT-2000 External Pacer Tester & Analyzer w/Case ..Call

Evaluating and testing all Atrial/Ventricular Pacemakers including Transthoracic Pacers and has been enabled to test all Medtronic pacers including the 5348 and the 5388.

A



B



C



D



E



C



D



E



F



Shown in carrying case

## BC Group Custom Kits

Looking to standardize on a set of test equipment and tools for your operation? BC Group has the capability to design custom instrument cases and instrument kits as well as manage your entire asset management program.



**C. Bacharach N<sub>2</sub>O Trace Gas Analyzer 3015-4790 .....\$5999**

Bacharach's TGA (Trace Gas Analyzer) is an advanced N<sub>2</sub>O Analyzer. It uses a highly accurate, non-dispersive IR cell providing superior stability and repeatability, with a measurement resolution of 1ppm-full range. It provides measurements in either ppm, real time or elapsed time TWA and it has a leak check mode with audible and visual alarms. It has an internal sampling pump and the self-contained purge-air bag provides a constant zero, enabling the Analyzer to be used in contaminated environments. The TGA has data-logging capabilities to store up to two hundred tests, which can be downloaded to a printer or to a computer.

- Continuous data-logging stores up to two hundred readings
- Time weighted average and elapsed time weighted average
- Real time is also a measurement mode
- Built-in purge cycle using a bladder bag provides a constant zero
- Displays ppm/TWA simultaneously
- Internal pump for remote sampling w/low flow indicator
- Built-in user-activated alarm
- 8 - 12 hours of operation on a full charge
- Rapid detection of changing N<sub>2</sub>O Levels
- Maintenance-free infrared N<sub>2</sub>O sensor
- Two Year Warranty

Optional and Replacement Accessories:

- 3015-3420 Inlet Filters.....\$44
- BC20-30114 TGA Hard Carrying Case.....\$430

**D. Viasensor G200-00N Nitrous Oxide monitor .....\$5470**

Nitrous oxide monitor 0 to 1,000 ppm N<sub>2</sub>O with internal pump.

- Includes: battery charger, sample tube/filters, Soda Lime CO<sub>2</sub> removal kit, operating manual and supplied in a hard carryingcase.

**Viasensor CO<sub>2</sub> Analyzers**

CO<sub>2</sub> Analyzer ranges are 0-10,000 ppm, 0-20% and 0-100% and all include internal pumps.

- Accessories Include: Battery Charger - Sample tube - Filters - Operating Manual

- E. G100-00N CO<sub>2</sub>, (0-20%).....\$3240**
- G100-10N CO<sub>2</sub>, (0-20%) O<sub>2</sub>, (0-100%).....\$3590**
- G100-01N CO<sub>2</sub>, (0-20%) RH Probe 15mm.....\$4560**
- G100-11N CO<sub>2</sub>, (0-20%) O<sub>2</sub>, (0-100%) RH Probe 15mm.....\$4745**
- G110-00N CO<sub>2</sub>, (0-100%).....\$3230**
- G110-10N CO<sub>2</sub>, (0-100%) O<sub>2</sub>, (0-100%).....\$3580**
- G110-01N CO<sub>2</sub>, (0-100%) RH Probe 15mm.....\$4555**
- G110-11N CO<sub>2</sub>, (0-100%) O<sub>2</sub>, (0-100%) RH Probe 15mm.....\$4640**
- G150-00N CO<sub>2</sub>, (0-10,000 ppm).....\$3230**
- G150-10N CO<sub>2</sub>, (0-10,000 ppm) O<sub>2</sub>, (0-100%).....\$3570**
- G150-01N CO<sub>2</sub>, (0-10,000 ppm) RH Probe 15mm.....\$4555**
- G150-11N CO<sub>2</sub>, (0-10,000 ppm) O<sub>2</sub>, (0-100%) RH Probe 15mm.....\$4645**

- Accessories
  - G-TP5 temperature probe.....\$255**
  - G-TP100 temperature probe (100mm).....\$285**

- F. G-HCASE Hard case.....\$230**

**A. Alnor EBT731 Electronic Balancing Tool .....\$3530**

The Alnor EBT731 Balometer Electronic Balancing Tool features a detachable, multi-purpose digital manometer that can be used with a variety of common test and balance tools, such as pitot, air foil, temperature, relative humidity probes or a 16-point velocity matrix. The EBT731 will become the tool of choice for contractors and facilities' personnel because of its ergonomic design and extremely lightweight.

- Accessories for the Alnor EBT731

<b>800187</b>	Air Flow Probe.....	<b>\$485</b>
<b>800220</b>	Temperature & Humidity Probe.....	<b>\$405</b>
<b>802601</b>	Soft Carrying Case.....	<b>\$315</b>
<b>801090</b>	16point Velocity Matrix.....	<b>\$420</b>
<b>801207</b>	1' x 5' and 3' x 3' hood expansion kit.....	<b>\$535</b>
<b>801206</b>	1' x 4' and 2' x 4' hood expansion kit.....	<b>\$535</b>

**HVAC Thermo-Anemometers**

**B. Alnor Velometer® AVM410 thermal anemometer**

A testing device for the HVAC test & balance professional that features a multi-purpose digital manometer, capture hood, relative humidity and temperature probe, airflow probe, pitot probe, static pressure probes or a velocity matrix (optional).

<b>Alnor AVM410</b> .....	<b>\$765</b>
<b>Alnor AVM430</b> .....	<b>\$1180</b>

**Extech 407123**

Handheld units. measures velocity & temp.....**\$575**  
This instrument measures air flow and temperature by placing the sensor into an airway such as a duct or a vent.

The sensor is situated at the end of the telescoping wand for convenience and has a protective sliding cover. The meter includes an RS-232 PC Interface jack for use with the Model 407001 Data Acquisition software and interface cable kit.

This meter is shipped fully tested and calibrated and, with proper use, will provide years of reliable service.

- Calibration Certificate Included

**ACS Environmental Chemical Monitoring Badges**

These vapor monitoring badges are primarily for medical, industrial hygiene and dental. Badges include monitoring of nitrous oxide vapor, halogenated anesthetic vapor, formaldehyde vapor and xylene vapor.

<b>C. Nitrous Oxide Vapor Monitor (N-10)</b> .....	<b>\$60</b>
<b>D. Formaldehyde Vapor Monitor (F-50)</b> .....	<b>\$60</b>
Halogenated Anesthetic Vapor Monitor (H-10-3).....	<b>\$60</b>
Xylene Vapor Monitor (OV-115).....	<b>\$60</b>

A



B



C



D



Nationwide  
On-Site Calibration





**A. BC Biomedical ESU-2400H ESU Analyzer with Kit .....\$12595**

The Patented ESU-2400H represents a totally new standard in full featured electrosurgery analyzers, with unprecedented measurement analysis and enhanced pulsed waveform compatibility.

**BC Biomedical ESU-2400 ESU Analyzer with Kit .....\$9960**

The ESU-2400 offers all of the measurement of the ESU-2050P with built-in loads and test automation.

- True RMS Readings Using DFA® Technology
- Performs Output, RF Leakage, CQM, and Power Load Curve Tests
- Autosequences Capability
- External Load Resistor Capability
- Calibration Level Accuracy
- 0 to 6400 ohms in 1 ohm increments

← **For more info on this series - Pages 19-26** →

**B. BC Biomedical TRL-2420 TISSUE RESPONSE LOAD .....\$648**

The TRL-2420 is an accessory to the BC Biomedical ESU-2400 that is used to simulate the effect of changing tissue impedance during electrosurgery. The TRL-2420 contains two incandescent bulbs that are silicone coated for safety. As RF energy from the ESU generator (DUT) is applied to the bulbs, the impedance of the bulb changes, simulating the impedance change of tissue.

Some RF generators have special output modes that detect the change of tissue impedance and automatically turn off the RF output when the change in impedance is detected. The ESU-2400 measures the current at the time when the RF output is turned off.

**Replacement Accessories:**

- C.**
- **BC20-00130** Accessory Kit.....\$584
  - **BC20-21107** 100-240 V Universal Power Supply....\$185

**D.** • **BC20-00131** ForceTriad™ PM Kit.....\$649

Contains everything you need to perform the newly revised ForceTriad™ PM procedure:

- External 200 Ohm load and REM cable for Cross Coupling Tests
- Footswitch Adapter for UFP Port Tests
- Bipolar Cable for Autobipolar Tests
- Convenient Carrying Case

**E.** • **BC20-00132** Conmed PM Kit.....\$852

• **BC20-00133** Conmed Automation Kit .....\$805

The latest ESU-2400 update includes an Autosequence for running the new PM procedure. The Autosequences use the accessory kit to guide the operator through more than 100 steps that are in the new PM test procedure.

• **BC20-00141** FT-10 Calibration Cable Kit .....\$299

Cable kit for use with the ESU-2400/H and ESU-2050/P Series.

• **BC20-41360** Communication Cable (USB Null Modem)..\$154

• **BC20-41341** Communication Cable (DB9F to DB9M).....\$154

**BC Biomedical Foot Switch Cables and Simulators for ESU-2400**

- **BC20-03000** Unterminated Foot Switch Cable.....\$299
- **BC20-03001** Force FX™ Foot Switch Cable.....\$584
- **BC20-03002** Conmed Foot Switch Cable.....\$584
- **BC20-03003** Covidien ForceTriad™ Foot Switch Cable \$584

**F.** • **BC20-03004** Foot Switch Simulator, triggers Cut/Coag/ Bipolar on Covidien Force FX™/ForceTriad™.....\$584

**G.** • **BC20-03005** Monopolar Handpiece Simulator.....\$584

- **BC20-03006** Foot Switch Cable - Olympus ESG-100.....\$584
- **BC20-03007** Foot Switch Cable - Olympus ESG-400....\$584
- **BC20-03050** Footswitch Port Adapter.....\$147

A

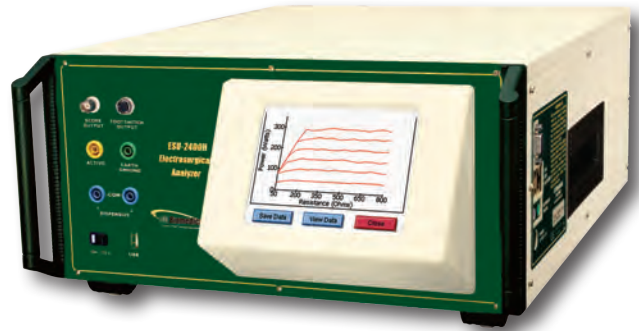

US Patent No. 9,883,903

B



C

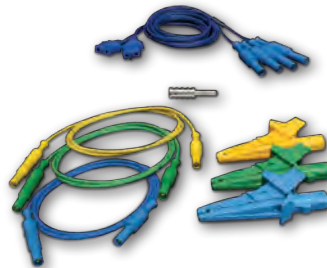

D



E



F



G



**A. BC Biomedical ESU-2350 ESU Analyzer with Kit.....\$7161**

The ESU-2350 Electrosurgical Unit Analyzer is a high accuracy, true RMS RF measurement system designed to be used in the calibration and routine performance verification of Electrosurgical Generators. It offers a higher degree of accuracy than previously attainable with conventional Electrosurgical Unit Analyzer designs.

The ESU-2350 provides an internal load bank with a range of 0 to 5500  $\Omega$  in 5  $\Omega$  increments. It is microprocessor based and utilizes a combination of unique hardware and software to provide accurate and reliable test results, even from “noisy” Electrosurgical Generator wave-forms such as “Spray”. The DFA 2™ Technology utilized in the ESU-2350 allows the system to aggressively digitize the RF waveforms produced by Electrosurgical Generators, analyze each individual digital data point and provide highly accurate measurement results.

**Included with Purchase**

- BC20-00142** ESU-2350 Accessory Kit (Test Leads)
- BC20-21107** Universal Power Supply
- BC20-20521** Power Adapter with International plugs
- NIST Traceable Calibration Certificate
- User Manual

A

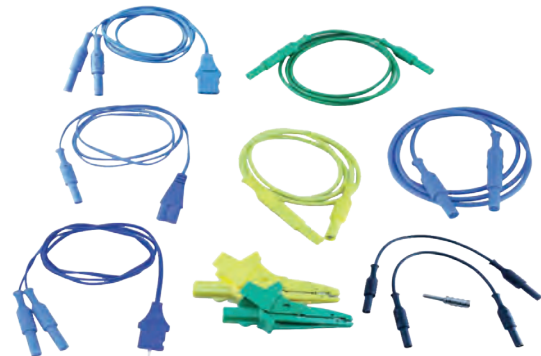

ESU-2350 Accessory Kit

**BC Biomedical Foot Switch Cables and Simulators for ESU-2350**

- **BC20-00142** Replacement Accessory Kit.....\$473
- **BC20-03000** Unterminated Foot Switch Cable.....\$299
- **BC20-03001** Force FX™ Foot Switch Cable.....\$584
- **BC20-03002** Conmed Foot Switch Cable.....\$584
- **BC20-03003** Covidien ForceTriad™ Foot Switch Cable.....\$584
- **BC20-03004** Foot Switch Simulator, triggers Cut/Coag Bipolar on Covidien Force FX™/ForceTriad™.....\$584
- **BC20-03006** Foot Switch Cable - Olympus ESG-100.....\$584
- **BC20-03007** Foot Switch Cable - Olympus ESG-400.....\$584
- **BC20-03050** Footswitch Port Adapter.....\$147

B

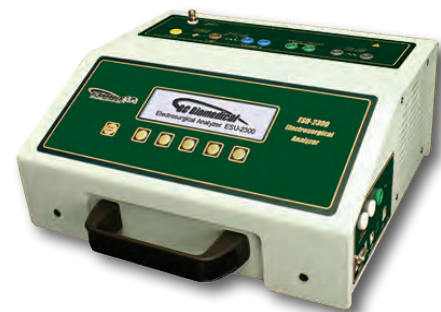

**B. BC Biomedical ESU-2300 ESU Analyzer with Kit.....\$5690**

- True RMS Readings Using DFA® Technology
- Performs Output, RF Leakage and CQM tests
- 15 Selectable Loads from 50 to 750 ohms
- Built-In RF Current Transformer • Crest Factor
- External Load Resistor Capability

**Replacement and Optional Accessories:**

- **BC20-00125** Replacement Accessory Kit.....\$621
- **BC20-21105** Universal Power Supply (Power cord not included see page 124).....\$98
- **BC20-41341** Communication Cable (DB9F to DB9M) \$154
- **BC20-41352** Communication Cable (USB).....\$42

C



D

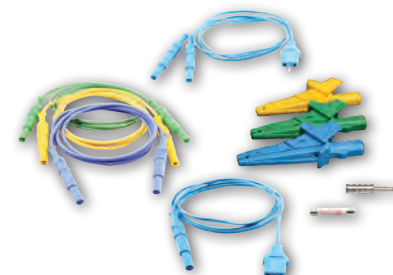

← For more info on this series - Pages 19-26 →

**C. BC Biomedical ESU-2000A ESU Analyzer with Kit.....\$3485**

- D. BC20-00121** Replacement Accessory Kit.....\$537
- **BC20-30108** Soft Carrying Case.....\$144

E



- E. BC Biomedical ESU-2050 ESU Analyzer.....\$6379**
- True RMS Readings Using DFA® Technology
  - mV, mV Peak, mA, Crest Factor and Wattage Displays
  - Waveform Capture, Storage, Display and Download

- BC Biomedical ESU-2050P ESU Analyzer.....\$6905**
- Same As ESU-2050 Plus Pulse Mode

**Replacement Accessories:**

- **BC20-21104** Universal Power Supply.....\$98
- **BC20-41341** Comm. Cable (DB9).....\$154
- **BC20-41352** Comm. Cable (USB).....\$42
- **BC20-00232** Cable, CT (3' BNC to BNC).....\$76
- **BC20-00126** Accessory Kit.....\$621



**Optional ESU-2050 Series Accessories**

**F. Pearson CT (for ESU-2050 Only)**

- **BC20-00230** 4100 Pearson CT 1:1.....\$757
- **BC20-00230** 4100 Pearson CT 1:1 with Cal.....\$893
- **BC20-00231** 411 Pearson CT 0.1:1.....\$757
- **BC20-00231** 411 Pearson CT 1:1 with Cal.....\$893

F



**G. CQM (for ESU-2050 Only)**

- CQM-2000 (REM/ARM/CQM Test Module).....\$394**

**H. Vishay-Dale NH-250 Precision Power Resistors & Adapters**

- 250 W • 1% Tolerance • Non-Inductive
- BC20-00200** 5 Ω \$238 **BC20-00211** 3000 Ω \$238
- BC20-00201** 10 Ω \$238 **BC20-00212** 4000 Ω \$238
- BC20-00202** 20 Ω \$238 **BC20-00213** 5000 Ω \$238
- BC20-00203** 30 Ω \$238 **BC20-00214** 1 Ω (50W) \$50
- BC20-00204** 50 Ω \$238 **BC20-00215** 125 Ω \$335
- BC20-00205** 100 Ω \$238 **BC20-00216** 150 Ω \$335
- BC20-00206** 200 Ω \$238 **BC20-00217** 400 Ω \$335
- BC20-00207** 300 Ω \$238 **BC20-00218** 800 Ω \$335
- BC20-00208** 500 Ω \$238 **BC20-00219** 1500 Ω \$335
- BC20-00209** 1000 Ω \$238 **BC20-00220** 10 Ω (50W) \$50
- BC20-00210** 2000 Ω \$238
- BC20-00240** Power Resistor Banana Jack Adapter Set (2)...\$30
- **Calibration for each resistor.....\$24**

G



**Resistor Sets**

- BC20-00251** Valleylab Force2 Performance Check Set (100 & 300 Ω).....\$477
- BC20-00252** Valleylab Force2 Calibration Set (1, 50, 100, 200, 300, 1000, 3000, 4000 Ω).....\$1717
- BC20-00253** Valleylab ForceFX™ Performance Check Set (100, 200, 300, 500 Ω).....\$952
- BC20-00254** Valleylab ForceFX™ Calibration Set (10, 30, 100, 200, 500, 1000, 2000, 3000 Ω).....\$2143
- BC20-00255** ForceTriad™ Performance Check Set (50, 100, 200, 300, 500 Ω).....\$1191
- BC20-00256** ForceTriad™ Calibration Set (1000, 5000 Ω).....\$477
- BC20-00258** Complete Set for Valleylab Generators \$3146
- BC20-00259** PM/Calibration Set for Valleylab FT-10 (5, 50, 100, 200, 300, 500, 5000 Ω).....\$1667
- **Calibration for each resistor.....\$24**

H



(Shown w/Optional Banana Jack Adapters)

**IET Decade Boxes**

- **RS-200** Basic Resistance (Ohm).....\$188
- **RS-201** Wide Range Resistance (Ohm).....\$345



PLEASE NOTE: Flowmeter/Pressure Gauge Shown is NOT INCLUDED.



**A. Ohmic AMM-15 Dew Point Meter.....\$1508**  
Verifies dew point of pressurized medical gases per ANSI & NFPA99. Range of -40° to 80°F. Max temp of +140°F. Max pressure of 175 PSI.

**B. Brass Fitting Kit BC20-40610.....\$280**

- 1 Brass Elbow 45° 1/4" MNPT x 1/4" FNPT
- 1 Brass Bushing 3/8" MNPT x 1/4" FNPT
- 1 Brass Tee 3/8" x 3/8" x 3/8" FNPT
- 1 Brass Bushing 3/8" MNPT x 1/8" FNPT 1
- 1 Brass Nipple 3/8" NPT
- 3 Quick Connectors 1/4" MNPT
- 1 Brass Elbow 90° 1/4" FNPT x 1/4" FNPT
- 1 Extension Hose - 2' 1/4" MNPT (Both Ends)
- 2 Brass Bushing 3/8" MNPT x 1/4" FNPT
- 2 Quick Connectors 1/4" MNPT
- Coupler x Coupler Assy (Two 1/4" MNPT Couplers & one nipple)
- 21 Quick Connectors 1/8" FNPT With Bushing (For Adapters)
- 1 Flexible pipe for O<sub>2</sub> sensor

**C. Medical Gas Outlet Fitting Kit BC20-40630.....\$649**  
Contains all of the fittings/adapters needed to test most outlets (Ohmeda®, Diamond, DISS, Puritan-Bennett & Chemtron) for common gases: Air, Oxygen, Nitrous Oxide, Vacuum, Evac and Nitrogen.

**Fitting Kit Combo BC20-40530 (Includes C & D).....\$940**

**Gelman Particulate Filters & Accessories**  
**1119 Poly Holder for 47 mm filters (50 PSI Max).....\$155**

**D. 1235 Aluminum Holder for 47 mm filters.....\$995**

**7245 Petri dishes, 47 mm filter protection (per 100).....\$85**

**E. 51147 Forceps for handling filters.....\$60**

**66149 PTFE Filters 47 mm x 0.45 micron (pack).....\$560**

**66408 47 mm x 0.45 micron filters (pack).....\$205**

**Flowmeters**

All prices include Calibration Certificate.

**2530A4A65BVBN Brooks Instruments 1 to 10 SCFM Air...\$399**

**F.2530A4A67BVBN Brooks Instruments 0.5 to 5 SCFM Air...\$399**

**2530A4A70BVBN Brooks Instruments 30 to 300 PM Air.....\$399**

**G.B18J201B126 Matheson 260 L w/Valve.....\$799**

**B18J201B127 Matheson 320 L w/Valve.....\$799**

H



**H. AG Instruments MG100 Medical Gas Analyzer.....\$17995**  
 All NFPA99 Gas Testing in One Instrument.  
 Measures O<sub>2</sub>, N<sub>2</sub>O, Water Vapor, CO<sub>2</sub>, CO, GHC, HHC, gas pressure and vacuum. Optional SO<sub>2</sub>, NO and NO<sub>2</sub> sensors as per US Pharmacopeia requirements. Connects directly to any gas outlet with gas pressure up to 190 psi (13 Bar). The most comprehensive, efficient and convenient piped medical gas testing solution in the world.

Simultaneous measurement of all NFPA-99 gases. Infrared Absorption water vapor measurement - much faster than current capacitive, electronic or chilled mirror sensors. Infrared Absorption sensors for N<sub>2</sub>O, CO<sub>2</sub> and Gaseous Hydrocarbons. High stability Electrochemical sensor for O<sub>2</sub> (Optional Paramagnetic sensor). High sensitivity Electrochemical cell to measure CO down to 0.01 ppm. Photo Ionization Detector with ppb sensitivity to measure Halogenated Hydrocarbons.

- MGPARA-O** Paramagnetic Oxygen Sensor.....\$4997
- MGHRCO2-O** CO<sub>2</sub> Option (0-100%).....\$1987
- MGUSP-O** Option for measuring additional gases, which are listed by US Pharmacopeia for medical air. See web store for details.....\$3650
- MGPRFHL-01** Stainless Steel Particulates Filter Holder...\$867
- MGSMPHS-01** Additional SS Sealed Sampling Hose with PTFE lining and inline filter.....\$715
- MGSPRBA-01** Spare battery for MG100.....\$197
- MGPRFLSC-01** Purge Filter Sachet (Pack of 6).....\$75

I



**I. Viasensor G210-10N0 Gas Analyzer .....\$7705**  
 Measures 0-100% Nitrous Oxide, 0-100% Oxygen and 0-2,000 ppm Carbon Dioxide

- Accessories Included: battery charger, operating manual, supplied in a Hard Carry Case.
- \*Requiring BC80-00246 Flow Restrictor.....\$47

\***Viasensor G210-11N Gas Analyzer .....\$8210**  
 Measures 0-100% Nitrous Oxide, 0-100% Oxygen, 0-2,000 ppm Carbon Dioxide and 0-500 ppm Carbon Monoxide

- Accessories Included: battery charger, operating manual, supplied in a Hard Carry Case.
- \*Requiring BC80-00246 Flow Restrictor.....\$47

**Viasensor CO<sub>2</sub> Analyzers**

**G110-00N** CO<sub>2</sub>, (0-100%).....\$3230  
 Accessories Include: battery charger - sample tube - filters- operator manual.

**Viasensor Calibration Gas**

- CG-N2O-50PV** N<sub>2</sub>O 50% / Balance 29L Bottle.....\$295
- CG-N2O-100V** N<sub>2</sub>O 100ppm / Balance N<sub>2</sub> 29L Bottle.....\$155
- CG-O2-50PV** O<sub>2</sub> 50% / Balance N<sub>2</sub> 29L Bottle.....\$140

**More Calibration Gas Available on BCGroupStore.com**

J



**J. Medical Gas Hard Carrying Case 221609 .....\$371**

Diced foam. Customize to meet your needs. Useable for any test equipment but this is the ideal size for a medical gas assortment. Dimensions: 21.5"x15.5"x9".

**Miller Nitrogen Purging Regulator 22-30-580.....\$340**  
Rugged heavy-duty industrial-grade regulators provide efficient and accurate regulation, and includes self-centering flowball. It has an output measure of 30 PSI and flow range is 10-60 55 SCFH

### Medical Gas Installation Tools

These two devices allow medical gas installers to comply with NFPA 99 2002, where it requires that the Nitrogen source of the purge gas shall be monitored and the installer shall be audibly alerted when the source content is low.

**K. LPWD Low Pressure Warning Device.....\$340**  
Designed to monitor pressurized gas and alarm when pressure drops below a user adjustable pressure range 25 to 110 PSI with a 300 PSI Max pressure rating.

**L. S3000-1/4 Low N<sub>2</sub> Pressure Gauge.....\$210**  
A general purpose 0 to 4000 PSI gauge suitable for use with Nitrogen. This gauge will alarm both visually and audibly when pressures fall below 500 PSI (± 150 PSI). Gauge has a 2" face and a 1/4" MNPT connection.

### Ansonics Ultrasonic Son-Tector Leak Detector Packages

A preventative maintenance tool, used to rapidly locate and pinpoint leaks and malfunctions in a wide variety of equipment.

**112 Package.....\$1095**

**M. 123 Package.....\$1200**

### N. Snoop® Liquid Leak Detector

Specially formulated liquid that adheres to vertical surfaces with better and longer bubbling to indicate leaks.

**Pack of Six 2 oz bottles.....\$40**

**Pack of Five 8 oz bottles.....\$45**

**One Gallon bottle.....\$98**

**O. Magnum Pro Combo Pneumatic Calibration Pump Model# MVP-600.....\$849**

- Contoured cushion handles
- Oversized check valve for smooth controlled operation
- Mash proof vent valve (No Needle Valve)

### P. Meriam Hand Pumps

**B34686 145 PSI Pressure Hand Pump (for Meriam Smart Manometer DN & GI Models).....\$448**

**B34700 650 mmHg Vacuum Hand Pump (for Meriam Smart Manometer AI Models).....\$448**

### Q. WIKA Analog Pressure Gauges w/ Calibration Certificate

Model	Range	Accuracy	Size	Price
232.54/30	0 to 0030" Hg	± 2/1/2% FS	2.5"	\$182
232.54/100	0 to 0100 PSI	± 2/1/2% FS	2.5"	\$179
232.54/300	0 to 0300 PSI	± 2/1/2% FS	2.5"	\$213
232.54/30-4"	0 to 0030" Hg	± 1.0% FS	4.0"	CALL
232.54/100-4"	0 to 0100 PSI	± 1.0% FS	4.0"	CALL
232.54/300-4"	0 to 0300 PSI	± 1.0% FS	4.0"	CALL
232.54/1000-4"	0 to 1000 PSI	± 1.0% FS	4.0"	CALL
232.54/3000-4"	0 to 3000 PSI	± 1.0% FS	4.0"	CALL

- 2.5" gauges 1.5% FS Accuracy
- 4" 1% FS Accuracy

K



L



M



N



O



P



Q



**O<sub>2</sub> cleaning available**  
**Call for more ranges**

**DIAGNOMATIC** by **Pro-Project**

A



B

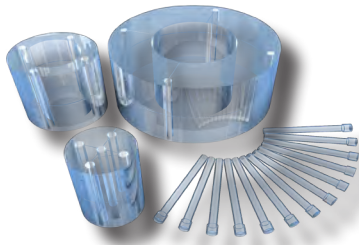

C



D

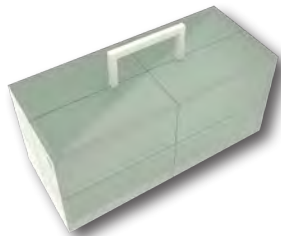

E



F



Computed Tomography (CT)

**Diagnomatic by Pro-Project**

**A. PRO-CT MK II (04-410).....\$5325**  
 The Pro-CT mk II phantom can be used for carrying out acceptance and constancy tests of computed tomography systems according to IEC 61223-3-5 and the AAPM (American Association of Physicists in Medicine) guidelines.

**B. PRO-CT Dose**  
 Set of homogenous cylinders designed to image paediatric and adult head and body. Used for CTDI measurement and to separate dose information for each.  
**(04-203) - Pro-CT Dose Head and Body nested set - L and M phantoms with 9 plugs and a case with a trolley (matte finish).....\$3915**  
**(04-204) - Pro-CT Dose Adult and Paediatric nested set – L, M and S phantoms with 13 plugs and a case with a trolley (matte finish).....\$4140**

Magnetic Resonance Imaging (MRI)

**C. PRO-MRI ACR Medium (09-301).....\$2150**  
 ACR accredited Medium MRI phantom for comprehensive evaluation of critical imaging parameters of magnetic resonance imaging (MRI) in a time efficient manner. The phantom can be used for the measurement of absolute values for calibration purposes. However, its design is optimized for time efficient daily quality assurance too.

**D. PRO-MRI SpineRect (09-201).....\$1530**  
 Rectangular MRI phantom simulating attenuation of the human spine.

Ultrasound

**E. PRO-US MTF (11-101).....\$3430**  
 The tissue-mimicking phantom for use in routine technical quality assurance (TQA). The PVA based material mimics the sound velocity and acoustic attenuation of the human tissue, is nontoxic, durable and easy to handle and maintain. Comparable and reproducible results can be achieved from a single image, making this a perfect daily QA tool. To determine the spatial resolution of phantom images, a modulation transfer function (MTF) is calculated by the Diagnomatic software using radial MTF algorithm.

**F. PRO-US Uniform (11-102).....\$2065**  
 The homogenous, tissue-mimicking phantom for use in routine technical quality assurance (TQA). The PVA based material mimics the sound velocity and acoustic attenuation of the human tissue, is nontoxic, durable and easy to handle and maintain. Comparable and reproducible results can be achieved from a single image, making this a perfect daily QA tool.

Mammography (MAM)

**G. Pro-MAM Accreditation FF (03-502).....\$1265**

This ACR accredited Full Field phantom was designed to test the performance of a digital mammographic system by evaluating the system's ability to image small structures similar to those found clinically: micro-calcifications, fibrous structures in ducts and tumor-like masses. It is similar to the Pro-MAM Accreditation phantom, the main difference being the size: the FF (Full Field) version is larger and covers the entire image detector, thus eliminating scatter.

G

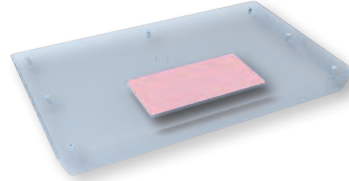

**H. Pro-MAM Accreditation (03-501).....\$ 810**

The phantom can test the performance of a mammographic system and its ability to image small structures similar to those found clinically: calcifications, fibrous calcifications in ducts and tumor masses.

H



**I. Pro-MAM Compress**

Calibrated scale for assessment of the breast compression force of mammography systems.

- (03-103) measuring range up to 25 kg.....\$565
- (03-103-34) measuring range up to 34kg.....\$655

I



Nuclear Medicine (NM)

**J. Pro-NM Performance (08-101).....\$2325**

The phantom for evaluating performance of positron emission tomographs (PET). Recommended for use in the evaluation of reconstructed image quality in whole body PET imaging.

J



For simulation of whole-body imaging especially using PET and camera-based coincidence imaging techniques.

Can also be used for determination of the coincidence count rate characteristics in brain and cardiac imaging, evaluation of the relationship between true coincidence count rate and radioactivity, determination of the address errors caused by address pile up, evaluation of the count loss correction scheme.

It has been designed in accordance with the recommendations by the International Electrotechnical Commission (IEC) and modified by the National Electrical manufacturers Association (NEMA).

**K. Pro-NM NEMA NU2 (08-107).....\$3325**

The phantom for NM and PET systems performance evaluation (collimator, artifacts, calibration, reconstruction parameters). It can be used to evaluate, for example: center-of-rotation error, non-uniformity artifacts, changes of radius-of-rotation on spatial resolution, reconstruction filters on spatial resolution, attenuation and scatter compensation.

K





L

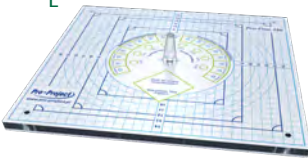

M

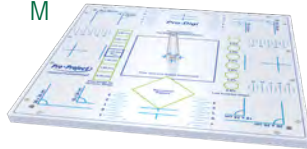

N

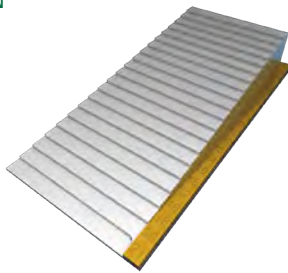

O



P

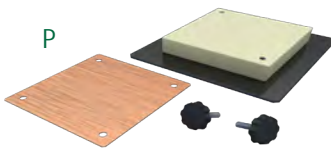

Q



R

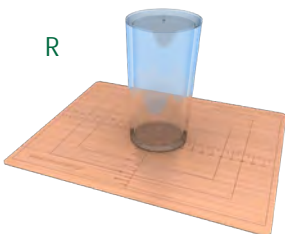

S

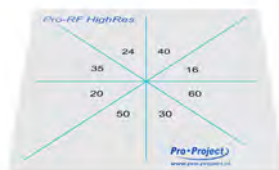

## Radiography / Fluoroscopy

**L. The Pro-Fluo 150 phantom (02-115).....\$1460**

Dedicated for acceptance and constancy tests of radiography and fluoroscopy equipment according to the new DIN 6868-150 standard

It can be used to measure:

- collimation/beam alignment
- position and size of the effective radiation field
- dynamic range
- spatial resolution
- contrast resolution
- homogeneity
- beam quality

**M. Pro Digi phantom (02-102).....\$990**

Dedicated for acceptance and constancy tests of digital radiography equipment.

**N. Pro-RF 21 Steps (02-305).....\$445**

A 21 step aluminium wedge for determination of the dose reproducibility and sensitometric curve shape, speed and mid-gradient of X-Ray screen-film radiography systems.

**O. Pro-RF Res 150 (02-120).....\$695**

The phantom for acceptance and constancy testing of Cone-Beam CT / Volume Tomography (DVT) in fluoroscopy according to DIN 6868-150.

**P. Pro-RF Al 25 (02-303).....\$315**

A 25 mm aluminum filter with insertion frame for mounting near the X-Ray tube.

**Q. Pro-RF AEC Cu (02-203).....\$355**

A set of high purity copper plates for testing Automated Exposure Control of radiography equipment. It can be mounted near the X-Ray tube and used instead of PMMA plates.

### R. Pro-RF Geometry

This device readily indicates a 1% or 2% misalignment at a 1 m focal-film distance (FFD), but it can be used at any FFD.

(02-106 Cylinder) \*Pictured.....\$640

(02-105 Cone).....\$345

### S. Pro-RF HighRes

The test phantom for evaluation of high contrast resolution of fluoroscopy system in one exposition. It consists of eight patterns of wire mesh in a pie shape.

(02-112 - 16-60 version).....\$620

(02-111 - 60-150 version).....\$595

Test Patterns

**T. Pro-Stand**

Adjustable stand, designed to make focal spot measuring procedures easy to perform, as well as ensure accurate results. It can also be used for the HVL measurements.

- (05-102) R/F applications.....\$735
- (05-103) - All applications including mammography.....\$960

**U. Pro-Slit (05-101).....\$1135**

The Pro-Slit phantom is the so-called slit camera for accurate measurement of the focal spot size according to IEC 60336:2020. Its main advantages are repeatability, accuracy and possibility to measure the size of any focal spot. Because of the small attenuation of the outer cover this tool can also be used with dental digital detectors - detector receives enough radiation to be triggered.

**V. Pro-Pinhole (05-701)- 0.010 mm.....\$1625**  
\*Other sizes available. See web store for details.

The Pro-Pinhole phantom is the so-called pinhole camera for accurate measurement of the focal spot size according to IEC 60336:2020. Its main advantages are repeatability, accuracy and the possibility to measure the size of different focal spots.

**W. Pro-HVL**

Different sets of high (99.9%) and standard (99.5%) purity aluminium plates for testing Half Value Layer.

- (05-201) standard set.....\$255
- (05-202) mammography set.....\$345

**X. Pro-HVL-cu (05-203).....\$380**

Different sets of high purity copper plates for testing Half Value Layer.

**Pro-Star**

With Pro-Star test Patterns focal spot size can be determined by observing the regions of blurring which occur when the pattern is radiographed by an x-ray source of finite dimensions. Radiation from different areas of the focal spot will cause a periodic blurring of the pattern due to penumbra effects. Knowledge of the geometric factors, and the distance from the center of the pattern to the region where blurring occurs, will permit the calculation of the focal spot size with the same accuracy as measurements made with a pinhole camera.

- Y. (05-604).....\$495
- Z. (05-607).....\$530

\*Five other patterns available. See web store for details.

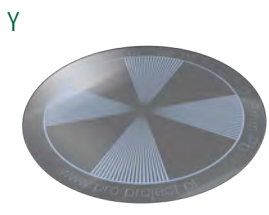
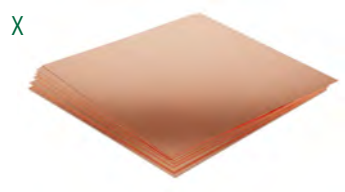
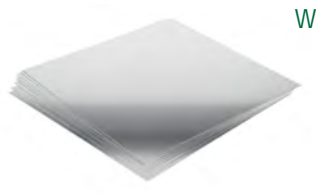

**Can't find what you're looking for from Pro-Project?  
View even more phantoms on our webstore at BCGroupStore.com!**

## ABOUT TITANIUM TOOLS

Once primarily used by the aerospace industry, use of titanium and titanium alloys has been steadily increasing primarily in the medical industry. Due to its natural properties, such as being non-magnetic, low in density, non-corrosive, nontoxic, possessing exceptional strength-to-weight ratios, and being biologically compatible with human tissue/bone, titanium is especially useful for artificial hip and knee replacement, heart valves, and spinal, maxillofacial & other implants. Most MRI machines range between 1.0 T to 1.5 T, with more powerful units at 3.0 T. Our non-magnetic titanium tools are made with 3.0 T safety in mind.

Non-magnetic, our titanium tools are completely secure for servicing bio-medical or diagnostic imaging machines, such as MRI scanners.

Ampco offers a variety of standard Non-Ferrous Tool Kits to meet your specific needs.

### Ampco Non-Ferrous Tool Kits

- A. M-39 Non-Ferrous Screwdriver Set**  
6 piece.....\$156
- B. M-41 Non-Ferrous Combo Wrench Set**  
(Inch) 7 piece.....\$431
- M-41M Non-Ferrous Combo Wrench Set**  
(Metric) 10 piece.....\$445
- M-42 Non-Ferrous Allen Wrench Set**  
(Inch) 7 piece.....\$115
- M-42M Non-Ferrous Allen Wrench Set**  
(Metric) 10 piece.....\$140
- M-46 Non-Ferrous Tool Kit**  
(Inch Tools only) 4 piece.....\$221
- M-47 Non-Ferrous Tool Kit**  
(Inch Tools only) 6 piece.....\$367
- C. M-48 Non-Ferrous Tool Kit**  
(Inch Tools Only) 11 piece.....\$763
- M-49 Non-Ferrous Tool Kit**  
(Inch Tools Only) 16 piece.....\$1040
- M-51 HAZMAT Non-Ferrous Tool Kit**  
(Inch Tools Only) 17 piece.....\$1362

### IMPRESX Non-Ferrous Tool Kits

Imprex International provides titanium and nonferrous tool solutions for the repair and maintenance of today's MRI, NMR and other high-Tesla environments using only the finest tool grade of titanium available-6AL-4V.

- D. GE 109 Non-Ferrous Tool Kit**  
(Inch Tools Only) 44 piece.....\$3460
- E. SMS-251 Non-Ferrous Tool Kit**  
(Inch & Metric Tools) 32 piece.....\$3075
- SMS-3517 Non-Ferrous Tool Kit**  
(Inch & Metric Tools) 36 piece.....\$3780



A



B



C



D



E



For hundred of products and the most up to date pricing, view the online store at [BCGroupStore.com](http://BCGroupStore.com)!

## A. RTI Black Piranha (Model Multi/657) 9729657-0.....\$15910

The Black Piranha and Ocean software are quick. Ocean can perform instant real-time analysis during your measurements as well as a report in the background. So when the work is done, if you want a complete report of your work – just press print!

Use your MS Windows tablet or laptop as both an interactive display during the measurements and as a powerful analysis tool when you are back at the office. All your measurements, along with the result and the report will be stored inside your tablet or laptop. No unnecessary, time-consuming data-transfer at the end of the day.

### Simply Plug-n-Play

Everything happens automatically – just plug-n-play. The Quick Check feature identifies your probe and selects the optimum Piranha settings for your measurements. It can also be programmed to start with your usual QA setup.

### A Piranha Never Forgets

During the measurements you will only see the desired values on your tablet or laptop but since the Piranha continues to work behind the scenes, you always have access to all of the data from each measurement. This enables you to perform trend analysis and study the history of each X-ray equipment – even months after you have completed your measurements.

### A Complete QA Solution Instantly

The Piranha comes ready-to-use with everything you need. It is really an all-in-one multifunction meter. Connect to your computer wireless or via USB and you have a complete QA-system!

### Position Check

Piranha has a unique feature that makes it possible to check the position of the detector before measuring. By using the “Position Check” function, you can verify that the detector area is fully irradiated. Possible field inhomogeneities are also neutralized.

### Piranha Key Features

- Automatic recognition of external probes
- One-shot HVL for Mammography, Radiography & more
- Small, compact & robust – easy to place
- Solid-state detectors = no need to compensate for temperature & pressure
- Backscatter protected
- Measures on scanning beams as well as tomosynthesis
- Long-lasting rechargeable battery
- Optimized for X-ray equipment from a large number of manufacturers
- Free firmware upgrades
- Can be used with ion chambers
- Firmware is easily updated via Internet or CD
- Bluetooth 100m
- Two Year Warranty
- Two Year Calibration Cycle



A



**Two Year Warranty and Two Year Calibration Cycle**  
**Free Ocean Next™ Software Updates**

## Ocean Next™ - the new power in X-ray QA software

### Advantage

For more advanced QA measurements than Quick, the Advantage license enables customization of templates to suit your specific needs. Predefined workflows, automation of steps, and graphs. In the Studio View, you can design single-page templates (including analysis and checklists) and important reports, e.g. with your own logo and own layout.

### Professional

For trend analysis and full traceability of your measurements. Ocean Next™ Professional allows you to build a holistic solution for your X-ray QA, by storing your measurements in a searchable database structured to your individual needs. The archived measurements are available for quick and intuitive retrieval.

Which Ocean Next™ suits you best?	Quick	Advantage	Professional
Built-in display function	•	•	•
Save function	•	•	•
Basic report printing	•	•	•
Basic Excel connection	•	•	•
Advanced report printing		•	•
Advanced Excel connection		•	•
User-defined tests & checklists		•	•
Analysis with pass/fail limits		•	•
Reporting		•	•
CT Dose Profiler support		•	•
Single-page templates		•	•
Multi-page templates			•
Site database			•

\*Ocean™ 2014 software is still available to download from the RTI website page: <https://rtigroup.com/support/rti-software-download-center/>

## Piranha Family of Meters

B



C



**B. RTI Black Piranha Premium Kit w/MAS.....Starts at \$21155**

The Piranha Premium Kit is a convenient and cost effective way to purchase a complete RTI QA package. Containing some of the most practical RTI tools, the Piranha Premium Kit saves both money and time with efficient pricing and thoughtful packaging.

Realizing that all users are not the same, the Premium Kit is available in six variations. Starting with the Piranha multi-meter, each kit includes a Piranha Dose Probe, Light Probe and Chamber Adapter or CT Dose Profiler.

Your own choice of mAs-meter (invasive or non-invasive) and how you would like to collect the values – PC or tablet. The Premium Kit includes a robust carrying case with cut-outs for each item included, including space for a T-20.

**CT Dose**

**C. CT Dose Profiler 9730013-00.....\$5200**

The CT Dose Profiler will, in just one helical scan, provide you a complete picture of the dose profile and it can also give you all CTDI parameters, dose length product (DLP), geometric efficiency and full width at half maximum (FWHM).

Piranha Model	Multi 657	R/F 557	CT 455	CT 455(IC)	Mammo 355	Dental 255
Mammography	●				●	
Rad & Fluoro	●	●				
Dental	●	●				●
CT	●	●	●	●		
kVp & Time	●	●	●	●	●	●
HVL & Total Filtration	●	●	●	●	●	●
Dose Probe	●	●				●
CT Dose Probe	●	●	●	●		●
MAS-1, MAS-2, Light Probe	●	●	●	●		●
Ion Chamber	●	●	●	●		●

All models include Tablet Compatibility, Ocean Compatibility, Waveform, Dose & Dose Rate, Quick HVL

All Prices and Features Subject to Change without Prior Notice

**D. Cobia Smart**

Cobia Smart is a simple-to-use instrument for checking that the output from an X-ray tube is correct. Place it beneath the X-ray tube, take an X-ray exposure, and instantly get an accurate reading. The measured values can be read directly from Cobia Smart's large and clear display, even from a distance.

Cobia Smart is perfect for anyone wanting to ensure that an X-ray device is functioning as it should. For example, Cobia Smart is ideal for checking fast and often that the kV and/or dose are not changing over time.

Cobia Smart has a very clear and rotatable color display, so you can read off measurement results fast and easily – even from a distance. The innovative smart display even shows the results right way up in measurement situations where the instrument needs to be positioned upside down.

Cobia Smart is available in English, Chinese, French, German, Japanese, Norwegian, Russian, Spanish, Swedish and Turkish.

• **9761003-NB R/F kV & Dose-No Bluetooth.....\$3415**

**E. Cobia Dental**

Cobia Dental is a simple-to-use instrument for checking that the output from Dental Intraoral X-ray tube is correct. Since the Cobia is so easy to position and doesn't require any complicated settings, anyone who works in the dental clinic can quickly and easily perform the routine inspection of the intraoral X-ray equipment. The Cobia Dental also has a rotatable color display and is available in different languages.

• **9764013-00 Intraoral, kV & Dose-No Bluetooth.....\$2705**

**F. Cobia Sense**

Cobia Sense is dedicated for use with an external detector such as RTI Dose Probe, Light Probe, CT ion chamber or external mAs probes. The wide selection of external probes enables a big flexibility in the performance of regular constancy checks for most modalities. The measured values can be read directly from the large and clear display, and are stored in the Cobia Sense for later viewing.

Thanks to the Plug-and-Play functionality the Cobia Sense will automatically recognize the different detectors you connect and instantly be ready for your measurements. This, together with the easy-to-read display, makes Cobia Sense the perfect tool for untrained users.

• **9763002-00 Cobia Sense with Dose Probe.....\$4360**  
 • **9763003-00 Cobia Sense with CT Dose Profiler.....\$8035**  
 • **9763005-00 Cobia Sense with CT Ion Chamber.....\$8035**



D

*Two Year Warranty and Two Year Calibration Cycle  
Free Ocean Next™ Software Updates*



E



F



G

### G. Cobia Flex

The Cobia Flex offers you the convenience to make your X-ray Quality Control as quick and accurate as possible. It's just as easy to use as the Cobia Smart but with more possibilities. The Cobia Flex has an internal detector, offers ability to connect different probes and ion chambers, and has built-in mAs. The measured values can be read directly from the large and clear display, and stored in the Cobia Flex to read later.

Cobia Flex users also have the possibility to use a tablet or a PC, saving data to computer, printing reports, using analyses and much more. The X-ray QA software, Ocean, exhibits the Cobia's capabilities and adds benefits that make the work flow more practical and simple. Ocean makes it possible to perform remote X-ray QA measurements with your Cobia Flex. You simply connect to your Cobia Flex via a USB cable to your PC or Tablet – then measure.

- 9762003-00 Cobia Flex with R/F.....\$7300
- 9762004-00 Cobia Flex with R/F w/mAs.....\$8610

Model	Cobia Smart	Cobia Flex		Cobia Sense		Cobia Dental
	R/F - kV & Dose	R/F with mAs	R/F	with CT	with PC Com	R/F - kV & Dose
Mammography		●	●	●	●	
Rad & Fluoro	✓	✓	✓	●	●	
Dental	✓	✓	✓	●	●	✓
CT		●	●	●	●	
Time	●	●	●	●	●	●
kV	●	●	●			●
Dose	●	●	●	●	●	●
Dose Rate	●	●	●	●	●	●
HVL	●	●	●			●
Total Filtration	●	●	●			●
Pulses	●	●	●	●	●	●
Pulse Rate	●	●	●			●
Dose/Pulse	●	●	●			●
Effective Time	●	●	●			●
Dose Probe		●	●	●	●	
CT Dose Profiler		●	●	●	●	
Internal MAS-1		●		●	●	
MAS-1, -2, -3 Probes		●	●	●	●	
Light Probe		●	●	●	●	
Ocean Compatability		●	●		●	
OCP		●	●		●	
Ion Chamber		●	●	●	●	
Soft Chell Case	●	●	●	●	●	●

### Guides

●	Standard function
●	Optional
●	Can use external detectors
●	Cannot use external detectors
●	Depending on external detector/probe

Rad & Fluoro.....	Meters for radiography and fluoroscopy
Mammography.....	Meters for mammography
CT.....	Meters for CT
Dental.....	Meters for dental (intraoral, panoramic or CBCT)
kVp & time.....	Measures kVp & time for supported modality
HVL / Total Filtr.....	Measures HVL and total filtration using internal filters
Dose & dose rate.....	Measures dose and dose rate
OCP.....	Open Communication Protocol
Dose Probe.....	Useful when higher sensitivity and minimal perturbation of field are required
CT Dose Profiler.....	For CT dose profile measurement
Ion Chamber.....	Chamber Adapter is required

## External Probes

### A. RTI Dose Probe 9730003-00.....\$1315

The RTI Dose Probe is an external dose probe, designed to perform very low dose rate measurements.

To avoid or minimize interference with AEC (Automatic Exposure Control) on X-ray equipment, the probe is very small. This also enables to fit it into the table bucky. Since it is a solid-state detector, no corrections for pressure or temperature are needed; nor bias voltage.

### B. T20 Dose Probe 9730015-00.....\$1315

T20 is a solid state detector dedicated for measurements on radiographic and fluoroscopic systems when it is crucial that the detector itself does not have any effect on the system. This probe's main task is measurement of the skin entrance dose and maximum dose rate in the radiographic and fluoroscopic field.

## MAS Probes

### C. MAS-1 9730005-00.....\$1865

The MAS-1 is an invasive probe that, with the Piranha, provides a direct reading of mA and mAs as well as waveforms. The probe can be used to measure tube current for all modalities including fluoroscopic and radiographic exposures.

### D. MAS-2 9730006-00.....\$1865

The MAS-2 is clamped easily on the high voltage cable. No connection inside the X-ray generator is required. Connected to the Piranha, the MAS-2 is ready for non-invasive measurements, reading mA, mAs, and capturing an mA waveform.

## Ion Chambers

### E. 10cm Ionization Chamber 9730025-00.....\$3810

### 30cm Ionization Chamber 9730026-00.....\$4515

The RTI CT Ion Chamber is a rugged, cylindrical pencil-shaped vented ionization chamber for CTDI measurements. The chamber is intended for measuring and monitoring the exposure output level of CT scanners in a phantom or free-in-air.

### F. Ion Chamber Magna 1 cc 9706100-00.....\$4200

The Magna 1cc ion chamber is designed especially for mammographic dose and dose rate measurements. It also has an excellent energy response and can be used for radiographic applications.

### G. Chamber Adapter 9730016-00.....\$1365

The Chamber Adapter makes it possible to use most Ion Chambers with the Piranha.

## BNT & TNT Adapters

RTI provides a range of adapter cables. These enable you to connect your Barracuda or Piranha to many different types of ionization chambers (not only the ones supplied by RTI).

- BNT Adapter 9706015-00.....\$350
- TNT Adapter 9706016-00.....\$350





H



I



J



K



L



piranha

### Holders

**H. Piranha Panoramic Holder 9744007-00.....\$500**

Piranha Panoramic Holder provides easy and quick positioning for measurement on Panoramic systems. The holder has fluorescent guides, making it possible to verify the detector position.

• **HVL Stand and Filters**

Adjustable stand for easier positioning of the HVL filter RTI Dose Probe, Piranha device, Barracuda MPD and R100. The stand can also be used for positioning when measuring upside down on an under-table tube or horizontal. Two different stands are available: one for 33 x 33 mm and one for 100 x 100 mm AI filters.

- **HVL Stand 9720910-00.....\$580**
- **HVL Filter Kit 9703045-00.....\$130**

### Cases

**I. Piranha Premium ALU Case 9742006-04.....\$685**

Made of light-weight aluminum, the Piranha Premium ALU Case is attractive and just “the right size” to provide a space for the Piranha and all its accessories included in the popular Piranha Premium Kits.

- *For the ALU Case Upgrade add \$254*

**J. RTI Soft Shell Case 9742008-00.....\$160**

RTI’s Soft Shell Case is a perfect solution for storage and transportation of your Piranha and a selection of its accessories. The soft shell case keeps the Piranha secure and ready to use.

**K. Piranha Outdoor Case 9742005-00.....\$685**

If a tough, dent-resistant, transport option is preferable, the new Piranha Premium Outdoor Case is the right case for you. Made with a rugged, high impact polypropylene exterior, this case is waterproof and can take a beating.

- *For the Outdoor Case Upgrade add \$389*

### Other

**L. Light Probe 9730007-00.....\$1840**

The Light Probe is designed to comply with the needs for QA in modern X-ray departments. With a monitor and a lux adapter the Light Detector measures the brightness on monitors, film viewing boxes and the ambient light in the room. The Light Probe has the same spectral response as the human eye. That makes it reliable for all different types of measurements, independent of the light source. The spectral response complies with the CIE V(λ) curve.

We carry the complete line of the RTI Black Piranhas. Call BC Group or visit us online to view the specifications & pricing of the perfect model for you!

A

**NEW**



A. BC Biomedical IPA-3100

The IPA-3100 Infusion Pump Analyzer is a compact and easy-to-use high performance single channel analyzer with an intuitive menu and full color touch screen..... **\$3250**

**Included with Purchase**

- **BC20-21115** Universal Power Adapter
- **BC20-40619** Tubing Kit
- **BC20-41377** Micro USB Cable

B



B. BC Biomedical IPA-3400 System

The IPA-3400 Infusion Pump Analyzer System is a Microprocessor-based system that tests flow rates.

- **IPA-3400-1** One Channel..... **\$5499**
- **IPA-3400-2** Two Channels..... **\$7236**
- **IPA-3400-3** Three Channels..... **\$9377**
- **IPA-3400-4** Four Channels..... **\$11519**

Optional Accessory Kit:

- **BC20-00161** Replacement Accessory Kit..... **\$304**
  - **BC20-40617** Replacement Tubing Kit..... **\$69**
  - **BC20-41360** Communication cable USB Null..... **\$154**
- C.
- **IPA-3900-FM** Flow Module..... **\$2142**
  - **IPA-3900-MB** Module Blanks..... **\$58**
  - **IPA-3400-F** Multi-Channel Frame..... **\$3357**
  - **BC20-20521** Power Cord, C-13 with interchangeable US, UK, AUS and Euro Plugs..... **\$86**

← **For more info on this series - Pages 29-38** →

C



D. BC Biomedical IPA-1000 System

The IPA-1000 Infusion Pump Analyzer System is a Microprocessor-based system that tests flow rates.

Individual Components:

- **IPA-1000** Infusion Pump Analyzer Display..... **\$1464**
- **MC3.5-1000** 3.5 mL Chamber..... **\$463**
- **MC35-1000** 35 mL Chamber..... **\$463**

Optional Accessories:

- **BC20-21111** Universal Battery Eliminator..... **\$76**
- **BC20-30109** Soft Carrying Case..... **\$176**
- **BC20-40607** IPA-1000 Interconnect Cable..... **\$47**
- **BC20-40615** Overflow Stopper & Tube (3.5 mL Chamber)..... **\$90**
- **BC20-40616** Overflow Stopper & Tube (35 mL Chamber)..... **\$90**

← **For more info on this series - Pages 29-38** →

Educational Assistance Program

BC Group has designed a program to assist schools with Biomedical Training Courses to obtain the latest BC Biomedical Test Equipment at a discounted price, when the products are used for instructional purposes. For more information, contact our main Sales office via email [sales@bcgroupintl.com](mailto:sales@bcgroupintl.com) or phone 800-242-8428.

D



Extech EX655 True RMS AC/DC Clamp-On Meter .....\$290

- 100 to 1000V
- 12 Functions including AC/DC Current
- -40 to 1832°F (1°F)
- Battery, test leads & general purpose bead wire temperature probe included
- NIST Traceable Calibration Certificate Included

**Multimeter Test Leads & Accessories**

- A. **8043S** "Softie" DMM 10 piece lead set.....\$33
- B. **Fluke 80K-40** High Voltage DMM Probe with Cal.....\$310

**Fluke Multimeters**

Fluke Digital Multimeters (DMMs) are on more tool belts, finding more problems, than any other comparable test tools. Each design is tested to the extreme: drop, shock, humidity, you name it. Every Fluke Digital Multimeter gives you what you need: accurate measurements; consistent, reliable performance; attention to safety; and the strongest warranty available.

Compare some of the Multimeters available from Fluke below. Each one has a unique set of features to fit your exact needs.

**Fluke Multimeter Accessories**

- C25 Carrying Case (Vinyl).....\$60

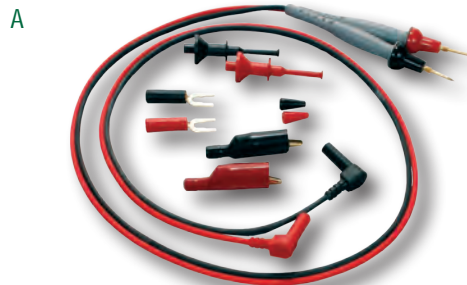

Model	Fluke 77-4 Call for Pricing	Fluke 114 Call for Pricing	Fluke 179 Call for Pricing	Fluke 87V Call for Pricing	Fluke 289 Call for Pricing
Price w/Cal Cert.					
True RMS	No	AC	AC	AC	AC/DC
Basic Accuracy	0.3%	0.5%	0.09%	0.05%	0.025%
Bandwidth	No	No	No	20 kHz	100 kHz
Auto/Man. Ranging	Yes	Yes	Yes	Yes	Yes
Digits	3.5	3.5	3.5	4.5	4.5
Counts	3,200	6,000	6,000	20,000	50,000
Temp.	No	No	+400 °C +752 °F	+1090 °C +1994 °F	+1350 °C +2462 °F
Datalogging	No	No	No	No	Yes



Sample Adapter

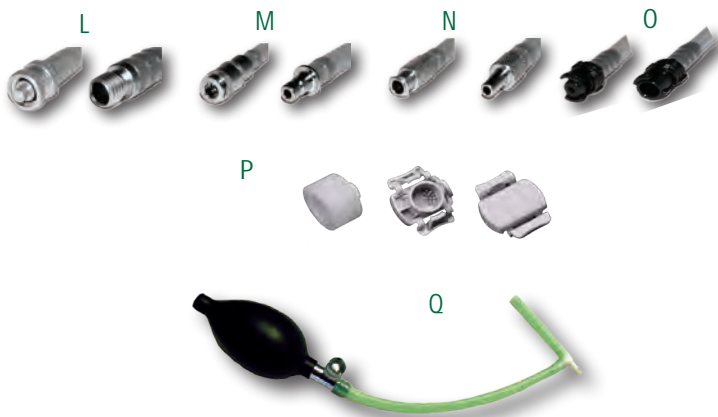

### BC Biomedical NIBP-1000 Simulator Series

The NIBP-1000 Series is a new family of high quality, low cost, high functioning Microprocessor-based NIBP Simulators. They were designed to meet the demand for a small, easy-to-use unit with a multitude of features to fit your exact needs. All NIBP-1000's come with a universal AC adapter

#### H. NIBP-1010 (NIBP Only).....\$1384

- Full Range Manometer • Flash Programmable
- Back Light
- Adult, Neonatal and Hypertensive modes
- Full Graphical Display • RS-232
- SpO<sub>2</sub> Ready - Compatible w/**MSP-2100** Module (Page 47)
- Includes One Free Adapter of Your Choice  
(If none specified, **BC20-40716** will be sent)

#### Optional Features:

- **-P** Peak Pressure Detect.....\$133
- **-BP** Peak Detect & Battery (Built-in Rechargeable)\$561

#### NIBP-1010KIT.....\$2039

Includes NIBP-1010-BP, Soft Carrying Case & Five Adapters

#### I. NIBP-1020 (NIBP, ECG Pace & Resp).....\$1584

- Has all of the NIBP-1010 features plus:
- Pace • Respiration
  - ECG - NSR • ECG - Test waveforms • Back Light
  - Includes One Free Adapter of Your Choice  
(If none specified, **BC20-40716** will be sent)

#### Optional Features:

- **-PA** Peak Pressure Detect & Alarm.....\$133
- **-BPA** Peak Detect, Alarm & Battery (Built-in Rechargeable).....\$561

#### NIBP-1020KIT (NIBP, ECG Pace & Resp).....\$2266

Includes NIBP-1020-BPA, Soft Carrying Case & Five Adapters

#### NIBP-1030.....\$2266

- Has all of the NIBP-1020 features plus:
- IBP • Temp
  - Arrhythmia • Leak Detect • Back Light
  - Includes One Free Adapter of Your Choice  
(If none specified, **BC20-40716** will be sent)

#### Optional Feature:

- **-B** Built-in Rechargeable Battery.....\$561

#### NIBP-1030KIT.....\$2720

Includes NIBP-1030-B, Soft Carrying Case, & Five Adapters

#### J. NIBP-1030-BE.....\$2834

Add Extended Patient Lead Connectors

#### NIBP-1030KIT-E.....\$2947

Includes NIBP-1030-BE, Soft Carrying Case, & Five Adapters

#### K. NIBP-1040Kit-E.....\$3969

Includes NIBP-1040-BE with ECG, Arrhy, IBP, Pace, Temp & Resp, Performance Waveforms, CO & FM plus ext leads, Soft Carrying Case and Six Adapters

#### Optional Accessories for NIBP-1000 Series:

- **BC20-30111** Soft Carrying Case.....\$61
- **BC20-41337** RS-232 Communication Cable.....\$154
- **BC20-41361** RS-232 Communication Cable, USB(A)M to Mini DIN Male.....\$154
- **L. BC20-40714** DINAMAP/Critikon Adapter.....\$46
- **M. BC20-40715** Quick Disconnect Adapter.....\$46
- **N. BC20-40716** Luer Adapter.....\$46
- **O. BC20-40717** Marquette Adapter.....\$46
- **P. BC20-40751** Welch-Allyn Adapter.....\$46
- **Q. BC20-40608** Bulb Adapter.....\$46
- **BC20-41339** USB to RS-232 Adapter.....\$154

View Invasive Blood Pressure Cables on pages 148-149

#### NIBP Adapter Kit BC20-40605.....\$121

Connector kit for NIBP testers. Save time and money by buying this kit. Includes 11 connectors.

A



**A. BC Biomedical FSX-1101.....\$1649**  
 The FSX-1101 is a digital SPO2 simulator with many features. It is small and light weight, yet very powerful and comes with a LIFETIME Warranty\*. It has a bright, 2.4" color touchscreen that, coupled with an intuitive menu structure, allows easy access and viewing of all setup and function parameters. SPO2 (in %) is selectable from six values with 2% accuracy. Heart Rate (in BPM) is selectable from 10 values with 1% accuracy. Three Perfusion Index values are also available.

The FSX-1101 can be connected to your BC Biomedical NIBP-1000 Series, PS-2100 Series or PS-2200 Series Patient Simulator via the auxiliary port (by using the provided cable). This allows for a synchronized SPO2 and ECG simulation for your monitors.

- **BC20-30123** Zippered Case.....\$149
- **BC20-21120** Power Supply with International Adapters.....\$74
- **BC20-41376** Cable, Sync, for FSX Series.....\$155
- **BC20-41377** Cable, Micro USB for FSX Series.....\$30

B



(FingerSims™ not included)

**B. BC Biomedical SPO-2000 Pulse Oximeter Module.....\$1060**  
 • 30, 60, 90, 120, 150 & 180 BPM Pulse Rates  
 • Requires BC Biomedical FingerSims™ to provide SpO<sub>2</sub> outputs of 80, 90 & 97%  
 • AC Adapter • Compact & cost-effective  
 • Maintenance-free

**Optional Accessory:**

- **BC20-40110** Hard Carrying Case for SPO-2000, FingerSims™ & Accessories.....\$125

C

(FingerSims™ not included)



**C. BC Biomedical MSP-2100 Pulse Oximeter Module**  
 • Requires BC Biomedical FingerSims™ and one of the following simulators: PS-2100, PS-2200 or NIBP-1000 to provide a calibrated pulse rate and synchronizes the SpO<sub>2</sub> waveforms provide by the simulator.

**MSP-2100.....\$596**

**BC Biomedical FingerSims™**

Provides SpO<sub>2</sub> outputs of 80, 90 & 97%. Simply squeeze on the FingerSims™ to generate a "pulse" or include a calibrated pulse rate by adding the SPO-2000 or the MSP-2100.

**D. Starter Kit FS-1000-SK (includes: 3 FingerSims™: 80, 90 & 97%, FingerSims™ Holder, Carrying Case and User Manual).....\$458**

**E. Replacement Set FS-1000-RS (80, 90 & 97% FingerSims™ only).....\$394**

D



E



← **For more info on these products - Pages 59-62** →

\* LIFETIME Limited Warranty requires product registration and return to factory for annual calibration

- A. OGX-1900-A Oxygen Analyzer** .....\$445
- Range - 0 to 100% O<sub>2</sub>
  - Accuracy - ± 1% full scale at Constant Temp. & Pressure
  - Resolution of Display - 0.1% O<sub>2</sub>
  - Sensor Life - 60 months in Air
  - Warranty - Analyzer Two Years, Sensor 18 Months

**Optional Accessory:**

- **All-11-60** Replacement Sensor.....\$113
- **ENCL-1052A** Carrying Case.....\$114

- B. OGX-1900-M Oxygen Monitor**.....\$660

The All-200M has all the same features as the All-2000A Oxygen Analyzer, but provides a Low Limit Alarm 15 to 100%.

**Optional Accessory:**

- **All-11-60** Replacement Sensor.....\$113
- **ENCL-1052A** Carrying Case.....\$114

← **For more info on this product - Pages 45-46** →

- C. OGX-1800A Handheld O<sub>2</sub> Oxygen Analyzer** .....\$310

This palm size oxygen analyzer features an advanced galvanic oxygen sensor that measures from 0.05% to 100% oxygen over a 32 month operating life with no maintenance required. 13,000 hours of battery use and wide variety of optional accessories make it an ideal cost effective choice for checking O<sub>2</sub> levels delivered to patients by anesthesia machines, ventilators, pediatric incubators and hoods, during emergency transport or concentrators.

- OGX-1800AR Handheld O<sub>2</sub> Oxygen Analyzer w/ Remote Sensor**....\$335

This palm size oxygen analyzer has all the same features as the OGX-1800A but with a remote sensor.

- D. R218P12 Handi+ Oxygen Analyzer**.....\$205

Maxtec has improved the Handi+ O<sub>2</sub> analyzer to be small and a one-touch calibration button makes it easy to use.

- Maxtec Max O<sub>2</sub>+AE Oxygen Analyzer**.....\$420

The MaxO<sub>2</sub>+AE is best used wherever an inline analyzer is required—especially useful with older ventilators or oscillators. Its patented, ergonomic design fits comfortably in your hand and features a simple, one-touch calibration and ON/OFF control. The MaxO<sub>2</sub>+AE will calibrate to room air (20.9%) or 100% oxygen. The Max O<sub>2</sub>+AE has a 24 month warranty on both the analyzer and the sensor, plus 5,000+ hours operation on 2 AA batteries.

**Replacement Anesthesia O<sub>2</sub> Sensors**

(See online guide for more information.)

- PSR-11-33-1**.....\$75
- E. PSR-11-915**.....\$140
- PSR-11-915-1**.....\$250
- PSR-11-915-2**.....\$120
- F. PSR-11-915-3**.....\$160
- PSR-11-915-4**.....\$120

**Replacement Respiratory O<sub>2</sub> Sensors**

(See online guide for more information.)

- G. PSR-11-33**.....\$75
- PSR-11-33-1**.....\$75
- PSR-11-33-2**.....\$80
- H. PSR-11-55**.....\$95
- PSR-11-58**.....\$120
- PSR-11-75-KE1**.....\$120
- PSR-11-75-KE2**.....\$120
- I. PSR-11-917-J**.....\$105
- PSR-11-917-J2**.....\$220
- PSR-11-917-M**.....\$105
- PSR-11-917-M1**.....\$220

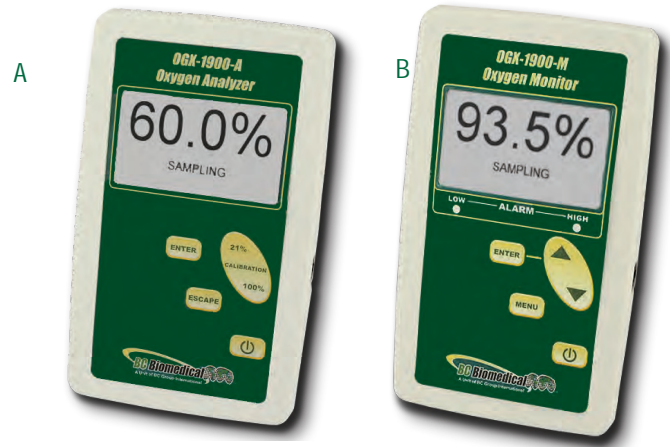

E



E. Fluke ScopeMeter 190-Series

**Fluke 196B/003** (100 MHz Bandwidth).....Call for Pricing

**Fluke 199BM** (200 MHz Bandwidth).....Call for Pricing

**Fluke 199CM** (200 MHz Bandwidth).....Call for Pricing

F



F. Fluke 123/003 ScopeMeter.....Call for Pricing

RS-232 compatible and comes with a 3-Year Warranty.

- 20 MHz Bandwidth • Two Scope Vertical Channels
- Two DMM Channels

Optional Accessories:

- C125 Soft Carrying Case.....Call for Pricing
- Calibration Certificate.....Call for Pricing

G

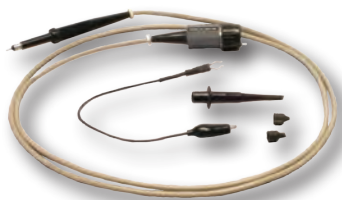

G. Gold Scope Probe Kits

The “Gold Probe” has been designed specifically for use with Tektronix, Hewlett Packard and other high performance oscilloscopes. The Gold-plated tips, sprung hook, ground lead, alligator tip and other critical interconnect points within the Gold Probe, provide excellent contacts for probing low-level analog signals.

- 4901-2** Basic 7-piece Kit.....\$56
- 4901-2K** Deluxe 17-piece Kit.....\$88

E



F



G



H

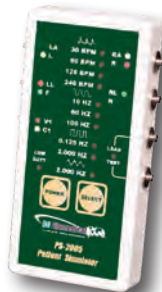

I



J



K



L



## BC Biomedical Patient Simulator Series

This Multi-Parameter Patient Simulator Series is the most comprehensive, easy to use family of Simulators on the market. These portable Simulators are intuitive to use since there are NO MORE CODES to enter. The simple scroll control of options makes them the best choice for your routine PM of patient monitoring systems and arrhythmia recognition training needs. The SpO<sub>2</sub> simulation option makes this series a truly unique and versatile tool.

- Powered by two 9V batteries or the battery eliminator
- Display backlight
- Full remote operation via RS-232
- Flash programmable for upgrades
- SpO<sub>2</sub>, Cardiac Output and Fetal/Maternal options
- Special programmable training modes

← For more info on this series - Pages 47-52 →

- All BP Waveforms available on all BP Channels
- E. • PS-2240 Patient Simulator with 4 BP Channels.....\$2784
- F. • PS-2220 Patient Simulator with 2 BP Channels.....\$2500
- PS-2210 Patient Simulator with 1 BP Channels.....\$2212
- PS-2105 Patient Simulator with 0 BP Channels.....\$1332
- G. • PS-2110 Patient Simulator with 1 BP Channels.....\$1453

### Optional

- MSP-2100 Pulse Oximetry Module.....\$596
- BC20-02300 Fetal/Maternal Option.....\$663
- BC20-02400 Cardiac Output Option.....\$663  
(Includes MCO-2100 Interface Module)
- FSX-1101 Pulse Oximetry Tester.....\$1649
- BC20-30107 Optional Soft Medium Carrying Case.....\$94

## BC Biomedical ECG Simulator Series

Microprocessor-based ECG Simulators Provides ECG Simulation with four waveforms with constant QRS duration and six machine performance testing waveforms.

- H. • PS-2005 5 Test Lead Model.....\$515
- I. • PS-2006 6 Test Lead Model.....\$538
- J. • PS-2010 10 Test Lead Model.....\$667

← For more info on this series - Page 47-50 →

## MicroSim Cardiac Output Simulator 1111.....Call

- Four Blood flow rates (3,5,6 & 7 L/min.) • Compact
- Two Blood temps (37 & 38 °C) • Dual injectile temps (0 & 20 °C)

### Optional Accessories:

- 1101 Baxter/Edwards Cable.....Call for Pricing
- 1103 HP Merlin Cable.....Call for Pricing
- 1106 Marquette Cable.....Call for Pricing
- Other Cables Needed?.....Call for Pricing

## K. Universal Banana-to-Snap/ECG Adapters BC20-17024.....\$406

- Set of 10 Adapters • Accepts 3 & 4 mm ECG Leads

## L. Banana-to-Snap/ECG Adapters BC20-17025.....\$87

- Set of 10 Adapters • Accepts **only** 3 mm ECG Leads

For complete selection of cables, go to Pages 147-149.



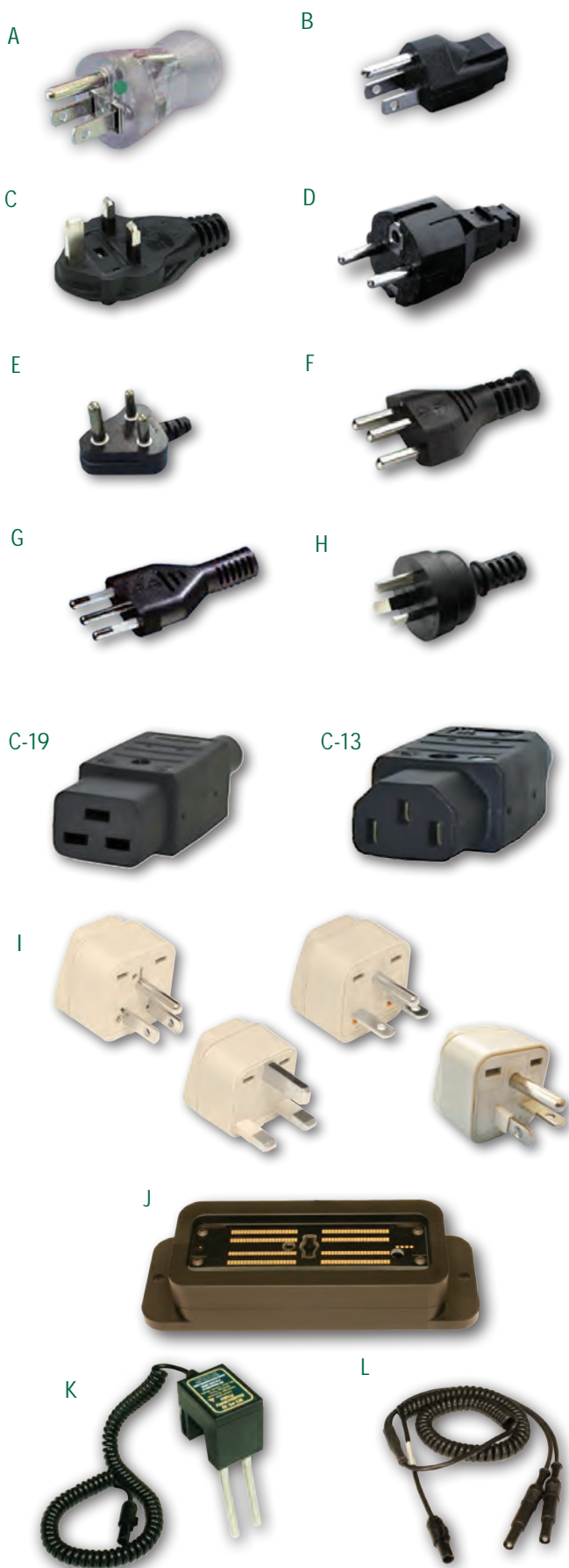

Typical Power Cord Options Available for the SA-2000-INTL Series & SA-2500 With C-19 Connector

A.	BC20-20400	North America Hospital Grade.....	\$86
B.	BC20-20401	Japan.....	\$86
C.	BC20-20402	United Kingdom.....	\$86
D.	BC20-20403	Schuko-Continental Europe with Schuko ground adapter.....	\$106
E.	BC20-20409	India/South Africa.....	\$86
F.	BC20-20410	Switzerland.....	\$86
G.	BC20-20412	Italy.....	\$86
H.	BC20-20416	Australia.....	\$86

Typical Power Cord Options Available for the ESU-2050, 2050P, 2300, ESU-2400, and IPA-3400 Series With C-13 Connector

A.	BC20-20500	North America.....	\$86
B.	BC20-20501	Japan.....	\$86
C.	BC20-20502	United Kingdom.....	\$86
D.	BC20-20503	Schuko-Continental Europe.....	\$86
E.	BC20-20509	India/South Africa.....	\$86
F.	BC20-20510	Switzerland.....	\$86
G.	BC20-20512	Italy.....	\$86
H.	BC20-20516	Australia.....	\$86

Power Cord Available for the IPA-3400 Series With C-13 Connector  
BC20-20521 C-13 with Interchangeable US, UK, AUS and Euro Plugs.....

\$103

Universal Adapters

I.	BC20-20200	US Plug Adapter(Grounded).....	\$32
	BC20-20201	Universal US 220V(Grounded).....	\$32
	BC20-20202	UK Plug Adapter.....	\$32
	BC20-20218	US 220V Plug Adapter(Grounded).....	\$32

Ultrasound Transducer Adapters (use with ULT-2000 Series)

	ULT-PA-10	Acuson/Siemens 8V5,15L8W,V5M,3V2C.....	\$668
	ULT-PA-11	Sonosite Transducers, including TEE.....	\$668
	ULT-PA-12	Acuson/Siemens 260-PIN.....	\$1413
	ULT-PA-13	Acuson/Siemens 156-PIN,V510B.....	\$936
	ULT-PA-14	ATL/Philips C9-5 Curved Array.....	\$1413
	ULT-PA-16	GE LogicQ and GE P9603AU.....	\$1413
	ULT-PA-17	Philips/ATL iE33 and iU22.....	\$1413
	ULT-PA-18	Philips/HP 4500, Sonos 5500/7500.....	\$912
	ULT-PA-19	Philips/CX50.....	\$1473
	ULT-PA-20	Toshiba PVF Series, 2B701-753E.....	\$936
	ULT-PA-21	Hitachi EUP-ES52M, EUP-Series Probes.....	\$1413
	ULT-PA-22	Aloka SSD-620, SSD-650.....	\$1413
	ULT-PA-23	All Transducers.....	\$782
	ULT-PA-24	Philips/ATL 256-pin, w/belled housing.....	\$1413
	ULT-PA-25	GE Logic Q, VIVID 6T,9T etc.....	\$1473
	ULT-PA-26	Acuson/Toshiba.....	\$2367
	ULT-PA-27	GE YMS/RT.....	\$936
J.	ULT-PA-29	Zonare Medical Systems.....	\$1043
	ULT-PA-30	GE Vivid E9.....	\$1580
	ULT-PA-32	Sonosite TEE X-Porte.....	\$1413

Ultrasound Dual Conductivity Probes (use with ULT-2000 Series)

K.	ULT-PC-10	Short Probe (3.43 inches / 87.1 mm).....	\$460
	ULT-PC-15	Medium Probe (4.46 inches / 113.2 mm).....	\$555
	ULT-PC-20	Set, Includes Long Probe (11.58 inches / 294.1 mm) and Short Probe (4.89inches / 124.2 mm).....	\$656
L.	ULT-PC-25	Adapter cable for Gus cleaning system.....	\$185
	ULT-PC-30	Dual Conductivity Probe (Flexible).....	\$438
	ULT-AC-10	Fork Adapter.....	\$460
	ULT-SP-20	Splitter.....	\$197

## AC & Battery Eliminator Cross Reference

Part #	Voltage	Item No.	Description	Price
A. *BC20-21104	6VDC	ESU-2050 ESU-2050P	Power Supply, Universal With C-13 Connector	<b>\$98</b>
B. *BC20-21105	9VDC	ESU-2300	Power Supply, Universal With C-13 Connector	<b>\$98</b>
*BC20-21107	12VDC	ESU-2400 ESU-2400H	Power Supply, Universal With C-13 Connector	<b>\$185</b>
*BC20-21108	12VDC	PFC-3000	Power Supply, Universal With C-13 Connector	<b>\$111</b>
C. BC20-21111	10VDC	ULT-2000 IPA-1000 DPM-2000	Battery Eliminator Interchangeable US, UK, AUS and Euro Adapters	<b>\$76</b>
BC20-21113	12VDC	UPM-DT-1000PA UPM-DT-1PA UPM-DT-10PA UPM-DT-100SP Rev A UPM-DT-50SP Rev A USP-50SP Rev A USP-100A Rev A	Battery Eliminator 12VDC Interchangeable US, UK, AUS and Euro Adapters	<b>\$76</b>
BC20-21114	10VDC	DA-2006 PS-2010 PS-2100 PS-2200	Battery Eliminator Interchangeable US, UK, AUS and Euro Adapters	<b>\$76</b>
D. BC20-21115	12VDC	NIBP-1010 NIBP-1020 NIBP-1030 NIBP-1040 SPO-2000 AA-8000 AA-8100	Battery Eliminator Interchangeable US, UK, AUS and Euro Adapters	<b>\$76</b>
BC20-21116	6VDC	AMM-15	Battery Eliminator 6VDC	<b>\$76</b>
BC20-21119	12VDC	UPM-DT-100SP Rev B UPM-DT-50SP Rev B USP-50SP Rev B USP-100A Rev B	Battery Eliminator 12VDC Interchangeable US, UK, AUS and Euro Adapters	<b>\$76</b>
E. BC20-21120	5VDC	FSX-1101	Power Supply with International Adapters	<b>\$74</b>

\*Power Cord not included, see page 145

A



B



C



D



E



A UNIT OF BC GROUP INTERNATIONAL, INC.

More Information online at [BCGroupStore.com](http://BCGroupStore.com)

- Quick Turnaround
- Centrally Located for US Customers
- Economical & Convenient
- All Types & Manufacturers Serviced

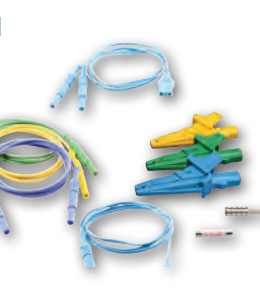
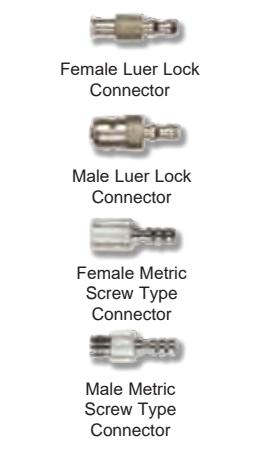
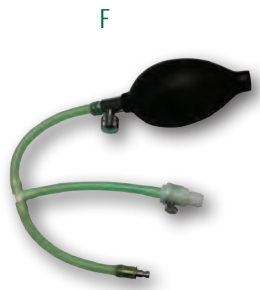
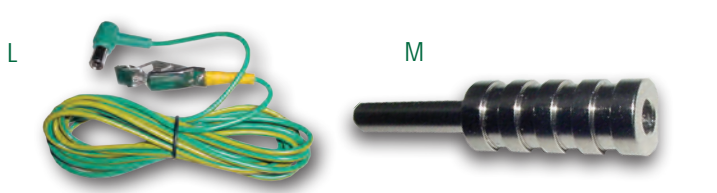
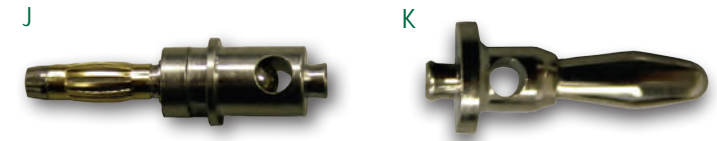
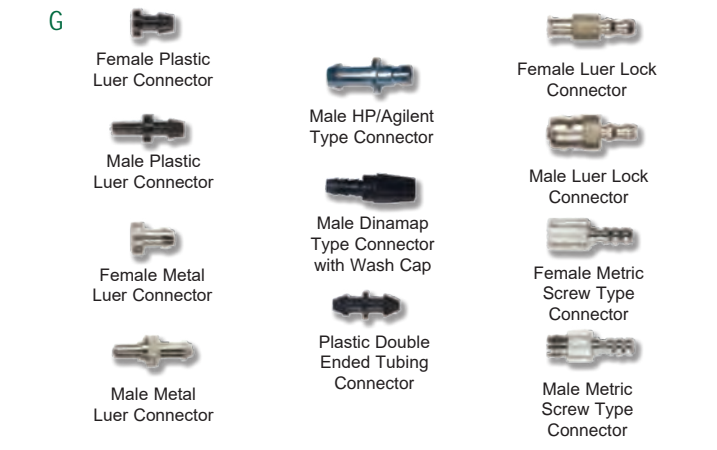
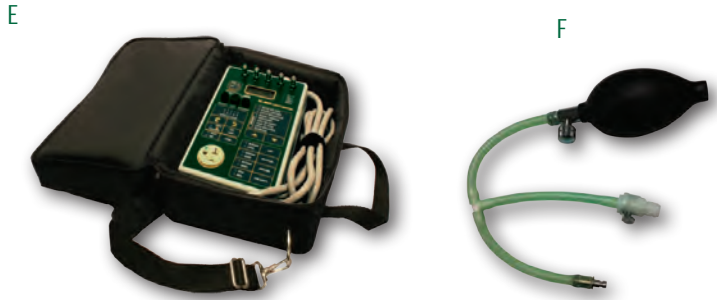

### BC Biomedical Soft Carrying Case Series

The Soft-sided, heavyweight Cordura® material carrying cases are a perfect fit for a multitude of test equipment and test accessories.

- BC20-30106 Small Soft Carrying Case.....\$66
- E. BC20-30107 Medium Soft Carrying Case.....\$94
- BC20-30108 Large Soft Carrying Case.....\$144
- BC20-30109 Large Carrying Case for IPA-1000 Series.....\$176
- BC20-30111 Carrying Case for NIBP 1000 series....\$61

### F. NIBP Fitting Kit BC20-40602.....\$93

- HP cuff adapter • CPC connector
- Inflation bulb • Silicone tubing & tee
- Quick coupler with 1/8" MNPT

### G. NIBP Adapter Kit BC20-40605.....\$121

Connector kit for NIBP testers. Save time and money by buying this kit. Includes 11 connectors.

### H. Universal Manometer Adapter Kit BC20-01005.....\$170

Everything you need to connect a pressure meter, regardless of application.

- 25 different fittings: CPC, luer, pipe, barb, etc.
- Inflation bulb with valve • Tygon tubing & more

### I. ESU-2000A Replacement Accessory Kit BC20-00121....\$537

ESU-2050 Replacement Accessory Kit BC20-00126.....\$621

ESU-2300 Replacement Accessory Kit BC20-00125.....\$621

ESU-2400/H Replacement Accessory Kit BC20-00130.....\$584

### J. Universal Banana-to-Snap/ECG Adapters BC20-17024 .....\$406

- Set of 10 Adapters • Accepts 3 & 4 mm ECG Leads

### K. Banana-to-Snap/ECG Adapters BC20-17025.....\$87

- Set of 10 Adapters • Accepts only 3 mm ECG Leads

### L. EP Adapter (Earth Plug 6mm) BC20-41510.....\$35

### M. Ground Plug with a banana jack adapter BC20-17026..\$18

### Defib & Pace Plates, Adapters & Cables (DA-2006 Series)

#### N. BC20-00427 Plastic Protective Plates (Set Included)....\$33

BC20-00432 Internal Paddle Adapters (Set Included)....\$65

BC20-41339 USB to RS-232 Adapter.....\$154

BC20-41341 Communication Cable.....\$154

BC20-00420 PhysioControl - Defib/Pace .....\$197

BC20-00423 Cable, Defib/Pacer Zoll \$125.....\$197

BC20-00426 Cable, Defib/Pacer HP/Agilent (Old Style barrel connector).....\$197

BC20-00433 Cable, Defib/Pacer Test Philips (New Style) \$197

BC20-00434 Cable, Defib/Pacer Test Cardiac Science \$197

### Safety Analyzer Cables

#### O. BC20-20100 BC Biomedical Kelvin Cable (DNI Type). Fit the following DNI/Fluke Biomedical® models: 231, 232, 234, 235, 431, 432, u-Test 2000 & all medTesters....\$191

BC20-20110 BC Biomedical Chassis (black) Cable (BC Biomedical/Dale Technology® Type).....\$131

#### P. BC20-20111 BC Biomedical External (red) Cable (BC Biomedical/Dale Technology® Type).....\$131

BC20-20115 BC Biomedical Kelvin Cable (BCB Type)\$154

## Temperature Cables



Description	Connector A	Connector B	BC Part #	Price
UT-1 Universal Temp Cable YSI-400 Series (PS-2110 & PS-2200 Series & NIBP-1030, NIBP-1040)	T(Male)	CC	BC20-41333	<b>\$131</b>
UT-2 Universal Temp Cable YSI-700 Series (PS-2110 & PS-2200 Series & NIBP-1030, NIBP-1040)	T(Male)	DD	BC20-41334	<b>\$131</b>
Universal Temperature Cable(Unterminated)	T(Male)	None	BC20-41351	<b>\$ 92</b>
UT-1 Temperature Cable, MaxiSim/416M YSI-400	NN	CC	BC20-30010	<b>\$135</b>
UT-2 Temperature Cable, MaxiSim/416M YSI-700	NN	DD	BC20-30020	<b>\$135</b>
UT-3 Temperature Cable, MaxiSim/416M Unterminated	NN	None	BC20-30030	<b>\$92</b>
Temperature Cable, Hewlett Packard YSI-400	NN	S(Male)	BC20-30035	<b>\$251</b>
Temperature Cable, Mindray YSI-400 (PS-2110 & PS-2200 Series & NIBP-1030, NIBP-1040)	XX	CC	BC20-41366	<b>\$129</b>

## Temperature Adapter Cables

Description	Connector A	Connector B	BC Part #	Price
Philips/HP Brown 2 Pin	A (Female ¼ - inch Phone Plug)	S (Male Brown 2-pin)	BC20-41336	<b>\$114</b>
Mindray/Datascope Round Connector	A (Female ¼ - inch Phone Plug)	S (Male Brown 2-pin)	BC20-41371	<b>\$110</b>
Mindray/Datascope D-Shape Connector	A (Female ¼ - inch Phone Plug)	XX (Male 5-pin)	BC20-41372	<b>\$110</b>
Spacelabs Connector	A (Female ¼ - inch Phone Plug)	ZZ (Male 10-pin)	BC20-41373	<b>\$110</b>
GE/Marquette Connector	A (Female ¼ - inch Phone Plug)	N (Male 11-pin)	BC20-41374	<b>\$110</b>
Draeger Connector	A (Female ¼ - inch Phone Plug)	BA (Male 7-pin)	BC20-41375	<b>\$110</b>

## Cardiac Output Cables

Description	Connector A	Connector B	BC Part #	Price
Cardiac Output Cable, HP Injectate Assembly	CC (1/4 - inch Phone Jack)	R (Female 4-pin)	BC20-41335	<b>\$197</b>

## Communication & Miscellaneous Cables



Description	Connector A	Connector B	BC Part #	Price
Communications cable for PS-2100, PS-2200, ULT & NIBP Series, DPM- 2200, DPM-2300 Series(Mini DIN M to DB 9 F) - also used with BC Flash Update Programming Utility Software	GG(Male)	Z(Female)	BC20-41337	<b>\$154</b>
Communication Cable for PSR-2200 to MPS-450 & Marq III(Mini DIN F to DB 9 M) - adapts the standard PSR-2200 Remote to the listed Fluke® Biomedical simulators	GG(Female)	Z(Male)	BC20-41338	<b>\$154</b>
Cable Adapter for PS-2100, PS-2200, ULT & NIBP Series, DA-2006(USB to DB 9 M) - used on a PC that does not have an RS232 port - includes cable and CD with driver software	EE	Z(Male)	BC20-41339	<b>\$154</b>
Communication Cable for DA-2006 & ESU-2000 Series(DB 9 M to DB 9 F)	Z(Male)	Z(Female)	BC20-41341	<b>\$154</b>
Communication Cable for PSR-2200 to Host Computer(Mini DIN F to DB 9 F)	GG(Female)	Z(Female)	BC20-41342	<b>\$154</b>
Communication Cable for the ESU-2000 Series USB(A)M to USB(B)M	EE	FF	BC20-41352	<b>\$ 42</b>
Communication Cable for DPM-2000 Series(1/8" Phone Plug to DB 9 F)	U(1/8" Male)	Z(Female)	BC20-21102	<b>\$147</b>
IPA-1000 Instrument to Chamber Interconnect Cable(Mini DIN M to Mini DIN M)	T(Male)	T(Male)	BC20-40607	<b>\$ 47</b>
Cable, Communication USB Null Modem (ESU-2400 to PC), USB(A)M to USB(A)M	EE	EE	BC20-41360	<b>\$154</b>
Communication RS232, USB(A)M to Mini DIN Male	GG(Male)	EE	BC20-41361	<b>\$154</b>

## Invasive Blood Pressure Cables – Mini DIN



For use with BC Biomedical brand Multiparameter Patient Simulators. These cables come with the mini DIN style connector (see connector style AA in the connector reference), which is the same as the connector supplied on older (vintage) Bio-Tek Instruments simulators and old model Fluke® Biomedical Multi-parameter simulators.

Monitor Manufacturer	Description (BP connector listed below to Male mini DIN at simulator end)	BC Part #	BP Cable Connector Key	Price
Burdick	10-pin Female	BC20-41309	B	\$191
Corometrics	12-pin Male (IUP Cable)	BC20-41343	M	\$222
Criticare	6-pin Male	BC20-41301	H	\$191
Critikon	6-pin Male	BC20-41301	H	\$191
Datascope	6-pin Female	BC20-41308	F	\$191
Datex DX-1	10-pin Female	BC20-41309	B	\$191
Fukuda Denshi FD-2 / DS3300	12-pin Male	BC20-41311	V	\$191
Hewlett Packard/Agilent/Philips	12-pin Male (40 uV)	BC20-41315	I	\$191
Hewlett Packard/Agilent/Philips	12-pin Male (5 uV) <b>(Most common)</b>	BC20-41314	I	\$191
Hewlett Packard/Agilent/Philips	12-pin Male (IUP Cable)	BC20-41344	PP	\$222
Invivo Research	6-pin Male	BC20-41301	H	\$191
Ivy Biomedical	6-pin Male	BC20-41301	H	\$191
Kontron/Roche	12-pin Female	BC20-41318	X	\$191
GE Marquette Eagle MQ-3	11-pin Male <b>(Most common)</b>	BC20-41320	N	\$191
GE Marquette MQ-2	9-pin Female	BC20-41319	OO	\$191
Medical Data Electronics (MDE)	6-pin Male	BC20-41322	H	\$191
Mennen Medical	10-pin Male	BC20-41323	II	\$191
Mindray M Series	12-pin Male	BC20-41369	YY	\$191
Mindray V Series	5-pin Male	BC20-41367	VV	\$197
Mortara	12-pin Male (5 uV) <b>(Most common)</b>	BC20-41314	I	\$191
Nihon Kohden* (See Note)	5-pin Male	BC20-41324	O	\$191
North American Drager	6-pin Male	BC20-41301	H	\$191
Ohmeda	6-pin Male	BC20-41301	H	\$191
Physio Control	6-pin Male	BC20-41301	H	\$191
Protocol Systems	6-pin Male	BC20-41301	H	\$191
Puritan Bennett PB-2	10-pin Female	BC20-41309	B	\$191
Siemens Medical Solutions SM-1	10-pin Male	BC20-41329	HH	\$191
Siemens Medical Solutions SM-3	15-pin Male	BC20-41328	Y	\$191
SMEC	6-pin Female	BC20-41308	F	\$191
Spacelabs (TK-1)	6-pin Male <b>(Most common)</b>	BC20-41301	H	\$191
Spacelabs/Squib	5-pin Male	BC20-41331	Q	\$191
Tektronix/Squib	6-pin Male	BC20-41301	H	\$191
Vitastat	5-pin Male	BC20-41331	Q	\$191
Vitatek/Squib	6-pin Male	BC20-41301	H	\$191
Witt	6-pin Female	BC20-41355	F	\$191
Universal BP Cable	Unterminated Pigtail	BC20-41340	Not Shown	\$ 85
Universal – Adapter	BP Cable Adapter – Mini DIN Male to Large DIN Female	BC20-40736	AA – BB	\$ 74
Universal – Adapter	BP Cable Adapter – Mini DIN Female to Large DIN Male	BC20-40737	BB – AA	\$ 74

\*To use the BC20-41324 IBP Cable with Nihon Kohden Smart Series Monitors, you will need the JP-910P cable adapter. The JP-910P can be bought directly from Nihon Kohden.



Blood Pressure Cables



Cardiac Output Cables



Communication Cables



Temperature Cables

## Invasive Blood Pressure Cables – Large DIN

These cables come with the large 5-pin DIN connector (see connector style BB in the connector reference) which is the connector supplied on older vintage Dynatech Nevada, DNI Nevada Blood Pressure cables and new Fluke® Prosi



Monitor Manufacturer	Description (BP connector listed below to Male large DIN at simulator end)	BC Part #	BP Cable Connector Key	Price
Description (BP connector listed below to Male mini DIN at simulator end)	10-pin Female	BC20-40303	B	<b>\$191</b>
BC Part #	6-pin Male	BC20-40301	H	<b>\$191</b>
BP Cable Connector Key	6-pin Male	BC20-40301	H	<b>\$191</b>
Price	6-pin Female	BC20-40302	F	<b>\$191</b>
Datex DX-1	10-pin Female	BC20-40303	B	<b>\$191</b>
Fukuda Denshi FD-2 / DS3300	12-pin Male	BC20-40304	V	<b>\$191</b>
Hewlett Packard/Agilent/Philips	12-pin Male (40 uV)	BC20-40310	I	<b>\$191</b>
Hewlett Packard/Agilent/Philips	12-pin Male (5 uV) <b>(Most common)</b>	BC20-40309	I	<b>\$191</b>
Invivo Research	6-pin Male	BC20-40301	H	<b>\$191</b>
Ivy Biomedical	6-pin Male	BC20-40301	H	<b>\$191</b>
GE Marquette Eagle	11-pin Male	BC20-40308	N	<b>\$191</b>
GE Marquette MQ-2	11-pin Male <b>(Most common)</b>	BC20-40307	W	<b>\$191</b>
Medical Data Electronics (MDE)	6-pin Male	BC20-40314	H	<b>\$191</b>
Mennen Medical	10-pin Male	BC20-40315	II	<b>\$191</b>
Nihon Kohden	5-pin Male	BC20-40316	O	<b>\$191</b>
North American Drager	6-pin Male	BC20-40301	H	<b>\$191</b>
Ohmeda	6-pin Male	BC20-40301	H	<b>\$191</b>
Physio Control	6-pin Male	BC20-40301	H	<b>\$191</b>
Protocol Systems	6-pin Male	BC20-40301	H	<b>\$191</b>
Puritan Bennett PB-2	10-pin Female	BC20-40303	B	<b>\$191</b>
Siemens Medical Solutions SM-1	10-pin Male	BC20-40318	HH	<b>\$191</b>
Siemens Medical Solutions SM-3	15-pin Male	BC20-40319	Y	<b>\$191</b>
SMEC	6-pin Female	BC20-40302	F	<b>\$191</b>
Spacelabs (TK-1)	6-pin Male	BC20-40301	H	<b>\$191</b>
Spacelabs/Squib	5-pin Male	BC20-40320	Q	<b>\$191</b>
Tektronix/Squib	6-pin Male	BC20-40301	H	<b>\$191</b>
Vitastat	5-pin Male	BC20-40320	Q	<b>\$191</b>
Vitatak/Squib	6-pin Male	BC20-40301	H	<b>\$191</b>
Universal BP Cable	Unterminated Pigtail	BC20-40332	Not Shown	<b>\$ 85</b>
Universal – Adapter	BP Cable Adapter – Mini DIN Male to Large DIN Female	BC20-40736	AA – BB	<b>\$ 74</b>
Universal – Adapter	BP Cable Adapter – Mini DIN Female to Large DIN Male	BC20-40737	BB – AA	<b>\$ 74</b>

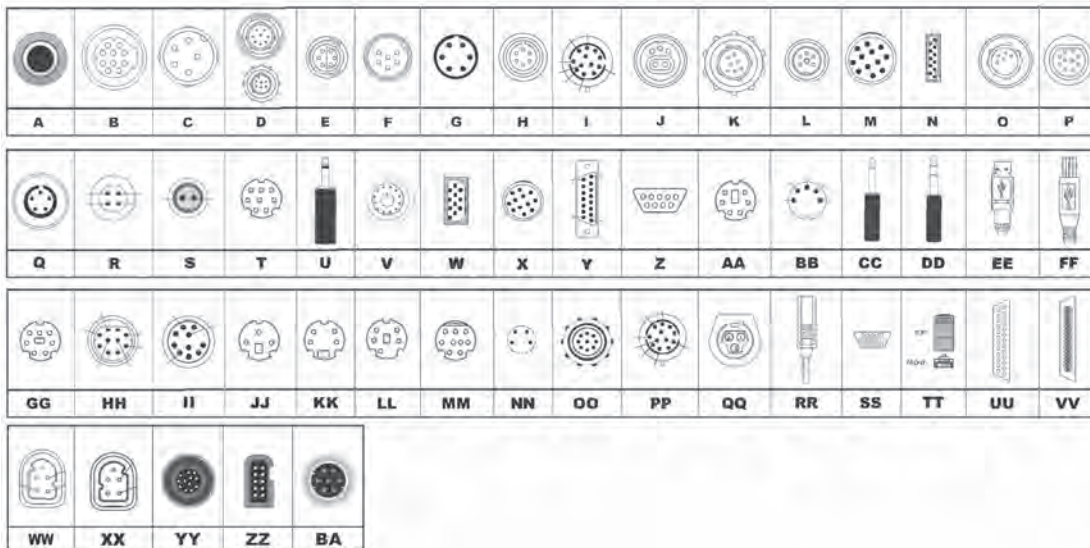

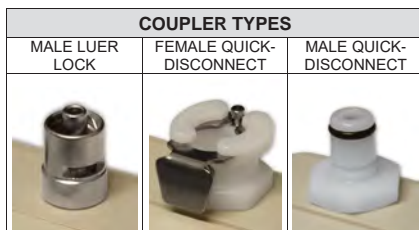
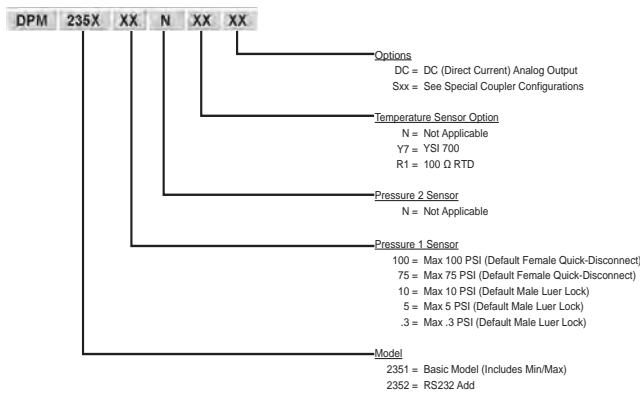
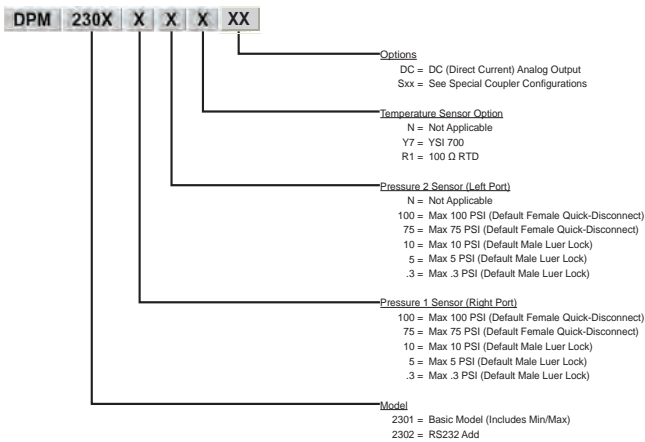

### BC Biomedical DPM-2300 Series

The DPM-2300 Series is a Microprocessor-based High Precision, High Resolution Digital Pressure Meter family. These meters measure both gas and liquid pressures and provide multiple engineering unit displays for the results. The unit (except the 2350 Series) may have one or two pressure sensors and an optional temperature sensor input to measure pressure and temperature all in one meter.

#### A. DPM-2301.....\$1198 (High Precision Pressure/Vacuum Meter w/enhanced res.)

- MAX and MIN Pressure Value Capture and Storage
- ± 0.05% FS Pressure Accuracy

##### Optional Features:

- DC DC Output.....\$178
- Second Pressure Sensor.....\$256
- Temp Option (YSI 700 or RTD).....\$203

#### DPM-2302.....\$1332 (adds RS-232 Serial Communications)

- Same features and options as the DPM-2301 with the RS-232
- ± 0.05% FS Pressure Accuracy

##### Optional Features:

- DC DC Output.....\$178
- Second Pressure Sensor.....\$256
- Temp Option (YSI 700 or RTD).....\$203

#### B. DPM-2351.....\$1198 (High Precision Differential Pressure/Vacuum Meter w/enhanced res.)

- MAX and MIN Pressure Value Capture and Storage
- ± 0.05% FS Pressure Accuracy

##### Optional Features:

- DC DC Output.....\$178
- Temp Option (YSI 700 or RTD).....\$203

#### DPM-2352.....\$1332 (adds RS-232 Serial Communications)

- Same features and options as the DPM-2351 with the RS-232
- ± 0.05% FS Pressure Accuracy

##### Optional Features:

- DC DC Output.....\$178
- Temp Option (YSI 700 or RTD).....\$203

#### DPM-235175NNFC.....\$1198

#### DPM-23017510NFC .....\$1448

(for ventilator and anesthesia service applications)



### SPECIAL COUPLER CONFIGURATIONS

Option	Pressure 1 Coupler (Right Port)	Pressure 2 Coupler (Left Port)
S01	Female Quick-Disconnect	Female Quick-Disconnect
S02	Female Quick-Disconnect	Male Quick-Disconnect
S03	Female Quick-Disconnect	Male Luer Lock
S04	Female Quick-Disconnect	Not Applicable
S05	Male Quick-Disconnect	Female Quick-Disconnect
S06	Male Quick-Disconnect	Male Quick-Disconnect
S07	Male Quick-Disconnect	Male Luer Lock
S08	Male Quick-Disconnect	Not Applicable
S09	Male Luer Lock	Female Quick-Disconnect
S10	Male Luer Lock	Male Quick-Disconnect
S11	Male Luer Lock	Male Luer Lock
S12	Male Luer Lock	Not Applicable

## A. BC Biomedical DPM-2200 Series

The DPM-2200 Series is a Microprocessor-based Digital Pressure Meter Family. They measure both gas and liquid pressures and provide 13 engineering unit displays for the results. The unit (except the 2250 Series) can have one or two pressure sensors and an optional temperature sensor input to measure pressure and temperature all in one meter.

**DPM-2201** (Pressure, Vacuum).....\$1129

- MAX and MIN Pressure Value Capture and Storage
- ± 0.05% FS Pressure Accuracy
- One Independent Pressure Range
- Choose Your Pressure Range: 0.3, 5, 10, 75 or 100 PSI

**DPM-2202** (Min and Max, RS-232).....\$1233

### Optional Features:

- DC DC Output.....\$178
- HF High Frequency Output.....\$310
- Second Pressure Sensor.....\$256
- Temp Option (YSI 700 or RTD).....\$203

**DPM-2251** (Differential Pressure, Vacuum).....\$1075

- Choose Your Pressure Range: 0.3, 5, 10, 75 or 100 PSI

**DPM-2252** (Min and Max, RS-232).....\$1174

### Optional Features:

- DC DC Output.....\$178
- HF High Frequency Output.....\$325
- Temp Option (YSI 700 or RTD).....\$203

← For more info on this product - Pages 55-56 →

**DPM-220210010NHF**.....\$1760

- 100 PSI-10 PSI-No Temp-HF output

## B. BC Biomedical DPM-2000 Series

This Microprocessor-based Family of Pressure/Vacuum Meters offers positive and negative pressure and is fully compatible with liquids and gases. The DPM-2001PLUS adds Capture and RS-232 capabilities to the DPM-2001 Base Model. While the DPM-2100 adds Temperature to the DPM-2001PLUS Model. All Models allow Selectable Engineering Units, including: PSI, MmHg, InH<sub>2</sub>O or CmH<sub>2</sub>O.

**DPM-2001** (Pressure, Vacuum).....\$1060

- Pressure to 100 PSI
- Vacuum to -13.50 PSI

**DPM-2001PLUS**.....\$1198

- Same features and options as the DPM-2001 with the addition of MIN/MAX Capture and RS-232.

**DPM-2100**.....\$1366

- Same features and options as the DPM-2001PLUS with the addition of Temperature capabilities to be used with any YSI 700 probe.

← For more info on this product - Pages 57-58 →

### Optional Accessories for BC Biomedical DPM Family

- **BC20-21111** Universal Battery Eliminator.....\$76
- **BC20-30106** Soft Carrying Case.....\$66
- **BC20-01006** YSI 700 Temp Probe.....\$203
- **22-02** 1/8" Hose Barb Non-valved In-Line CPC Coupling Insert (Male).....\$14
- **BC20-21102** Communication Cable(1/8" Phone Plug to DB 9 F)(DPM-2000 Series Only).....\$147
- **BC20-41337** Communication Cable(Mini DIN M to DB 9 F) (DPM-2200/2300 Series Only).....\$154
- **BC20-41339** Communication Cable (USB to DB 9 M).....\$154
- **BC20-41361** Communication Cable (USB to Mini DIN M) (DPM-2200/2300 Series Only).....\$154

**Universal Manometer Adapter Kit BC20-01005**.....\$170

Everything you need to connect a pressure meter, regardless of application, all in one small case.

- 25 different fittings • Inflation bulb with valve • Tygon tubing



\*All DPM-22XX and 225X models come with male luer connectors.

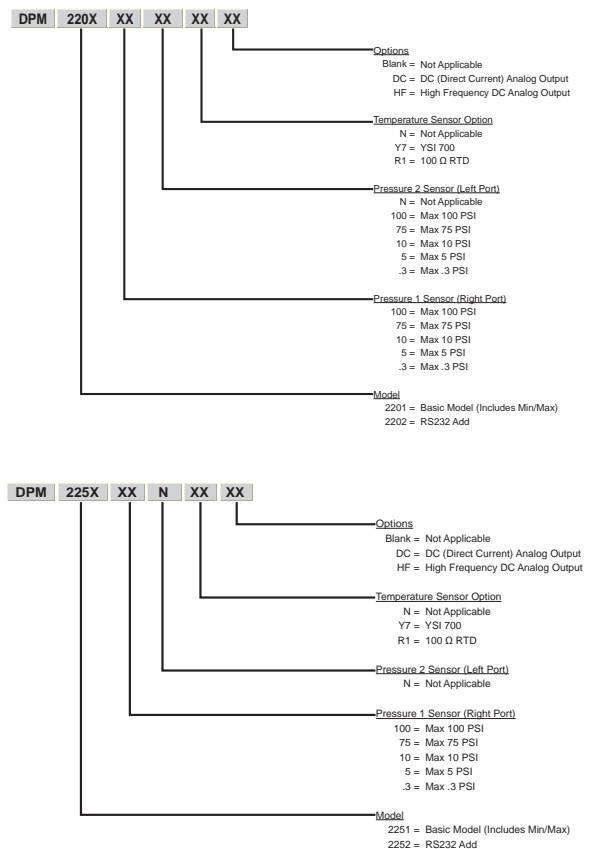

### EYE SURGERY EQUIPMENT USERS PLEASE NOTE:

Recommended part number for DPM Pressure Meter when servicing Eye Surgery Equipment.

**DPM-220210010NHF**



C



**C. Meriam M1 Smart Digital Manometers**

- Prices include NIST Calibration Certificate
- M1004 Digital Manometer:  $\pm 0.25\%$  FS

Model	Range	Price
M1004-AN0015	Absolute 0-15 psi (755 mmHg)	\$790
M1004-AN0030	Absolute 0-30 psi (1551 mmHg)	\$790
M1004-AN00100	Absolute 0-100 psi (2585 mmHg)	\$790
M1004-DN0001	Differential -1-1 psi	\$790
M1004-DN0005	Differential -5-5 psi	\$790
M1004-DN0015	Differential -14.5-15 psi	\$790
M1004-DN0030	Differential -14.5-30 psi	\$790
M1004-DN0050	Differential -14.5-50 psi	\$790
M1004-DN0100	Differential -14.5-100 psi	\$790
M1004-CN0001	Compound -1-1 psi	\$790
M1004-CN0005	Compound -5-5 psi	\$790
M1004-CN0015	Compound -14.5-15 psi	\$790
M1004-CN0030	Compound -14.5-30 psi	\$790
M1004-CN0050	Compound -14.5-50 psi	\$790
M1004-CN0100	Compound -14.5-100 psi	\$790

D



**D. Meriam M2 Smart Digital Manometers**

- Prices include NIST Calibration Certificate
- M2004 Digital Manometer:  $\pm 0.25\%$  FS

Model	Range	Price
M2004-AN0015	Absolute Non-Isolated 15 psi	\$1115
M2004-AN0030	Absolute Non-Isolated 30 psi	\$1115
M2004-AN0100	Absolute Non-Isolated 100 psi	\$1115
M2004-AI0015	Absolute Isolated 15 psi	\$1185
M2004-AI0030	Absolute Isolated 30 psi	\$1185
M2004-AI0100	Absolute Isolated 100 psi	\$1185
M2004-AI1000	Absolute Isolated 1000 psi	\$1185
M2004-DN0001	Differential Non-isolated -1-1 psi	\$1115
M2004-DN0005	Differential Non-isolated -5-5 psi	\$1115
M2004-DN0015	Differential Non-isolated -14.5-15 psi	\$1115
M2004-DN0030	Differential Non-isolated -14.5-30 psi	\$1115
M2004-DN0050	Differential Non-isolated -14.5-50 psi	\$1115
M2004-DN0100	Differential Non-isolated -14.5-100 psi	\$1115
M2004-DI0001	Differential Isolated -1-1 psi	\$2050
M2004-DI0005	Differential Isolated -5-5 psi	\$2050
M2004-DI0015	Differential Isolated -14.5-15 psi	\$2050
M2004-DI0030	Differential Isolated -14.5-30 psi	\$2050
M2004-DI0050	Differential Isolated -14.5-50 psi	\$2050
M2004-DI0100	Differential Isolated -14.5-100 psi	\$2050
M2004-DI0300	Differential Isolated -14.5-300 psi	\$2050
M2004-DI0500	Differential Isolated -14.5-500 psi	\$2050

## A. Meriam M2 Smart Digital Manometers (Continued)

M2004 Digital Manometer:  $\pm 0.025\%$  FS

Model	Range	Price
M2004-CN0001	Compound Non-Isolated -1-1 psi	\$1115
M2004-CN0005	Compound Non-Isolated -5-5 psi	\$1115
M2004-CN0015	Compound Non-Isolated -14.5-15 psi	\$1115
M2004-CN0030	Compound Non-Isolated -14.5-30 psi	\$1115
M2004-CN0050	Compound Non-Isolated -14.5-50 psi	\$1115
M2004-CN0100	Compound Non-Isolated -14.5-100 psi	\$1115
M2004-CI0005	Compound Isolated -1 psi to 5 psi	\$1185
M2004-CI0015	Compound Isolated -5 psi to 15 psi	\$1185
M2004-CI0030	Compound Isolated -14.5 psi to 30 psi	\$1185
M2004-CI0050	Compound Isolated -14.5 psi to 50 psi	\$1185
M2004-CI0100	Compound Isolated -14.5 psi to 100 psi	\$1185
M2004-CI0300	Compound Isolated -14.5 psi to 300 psi	\$1185

## B. Meriam MG-F16BN Digital Pressure Gauges

Model	Type	Accuracy	Range	Price
MG-F16BN	9P206-1	$\pm 0.25\%$	-30 inHg to 15 PSIG	\$375
MG-F16BN	9P206-3	$\pm 0.25\%$	-30 inHg to 100 PSIG	\$375
MG-F16BN	9P206-5	$\pm 0.25\%$	-30 inHg to 200 PSIG	\$375
MG-F16BN	9P206-7	$\pm 0.25\%$	0 to 5 PSIG	\$375
MG-F16BN	9P206-8	$\pm 0.1\%$	0 to 5 PSIG	\$460
MG-F16BN	9P206-9	$\pm 0.25\%$	0 to 15 PSIG	\$375
MG-F16BN	9P206-10	$\pm 0.1\%$	0 to 15 PSIG	\$460
MG-F16BN	9P206-11	$\pm 0.25\%$	0 to 60 PSIG	\$375
MG-F16BN	9P206-12	$\pm 0.1\%$	0 to 60 PSIG	\$460
MG-F16BN	9P206-13	$\pm 0.25\%$	0 to 100 PSIG	\$375
MG-F16BN	9P206-14	$\pm 0.1\%$	0 to 100 PSIG	\$460
MG-F16BN	9P206-15	$\pm 0.25\%$	0 to 200 PSIG	\$375
MG-F16BN	9P206-16	$\pm 0.1\%$	0 to 200 PSIG	\$460
MG-F16BN	9P206-17	$\pm 0.25\%$	0 to 300 PSIG	\$375
MG-F16BN	9P206-18	$\pm 0.1\%$	0 to 300 PSIG	\$460
MG-F16BN	9P206-19	$\pm 0.25\%$	0 to 500 PSIG	\$375
MG-F16BN	9P206-20	$\pm 0.1\%$	0 to 500 PSIG	\$460
MG-F16BN	9P206-21	$\pm 0.25\%$	0 to 1000 PSIG	\$375
MG-F16BN	9P206-22	$\pm 0.1\%$	0 to 1000 PSIG	\$460
MG-F16BN	9P206-23	$\pm 0.25\%$	0 to 2000 PSIG	\$375
MG-F16BN	9P206-24	$\pm 0.1\%$	0 to 2000 PSIG	\$460
MG-F16BN	9P206-25	$\pm 0.25\%$	0 to 3000 PSIG	\$466
MG-F16BN	9P206-26	$\pm 0.1\%$	0 to 3000 PSIG	\$460
MG-F16BN	9P206-27	$\pm 0.25\%$	0 to 5000 PSIG	\$375
MG-F16BN	9P206-28	$\pm 0.1\%$	0 to 5000 PSIG	\$460

• NIST Certificate with Data (Z1134).....\$125

A



B



## BC Group Asset Management

We can even develop, implement and manage a calibration exchange program for your organization. The flexibility of our system guarantees that we can meet your needs and if you are not sure what you need our knowledgeable staff will guide you in choosing a system that will work for you.



**NEW**

SA-2600 with Protective Boot

**NEW**



**SA-2000 Series Protective Boot Accessory**  
(Pictured with SA-2600) fits all the models below.

**Introductory Price of only \$99!**

**SA-2600 Sold Separately**

← For more info on this series - Pages 63-68 →



**Model Price (ea)**

**SA-2000 \$926**

**SA-2001 \$1268**

**SA-2005 \$1673**

**SA-2010 \$1997**

**SA-2010S \$2333**

**SA-2600 \$2495**

Models	SA-2000	SA-2001	SA-2005	SA-2010	SA-2010S	SA-2600
<b>Voltage (Rating)</b>	90 to 264 VAC	90 to 264 VAC	90 to 264 VAC	90 to 264 VAC	90 to 264 VAC	90 to 264 VAC
<b>Current (Rating)</b>	20 A	20 A	20 A	20 A	20 A	20 A
<b>RS-232</b>	On “-R	On “-R	On “-R	On “-R	On “-R	Micro USB
<b>Measures:</b>						
<b>Voltage (VAC)</b>	No	90 to 264 (± 3% R)	90 to 264 (± 3% R)	90 to 264 (± 3% R)	90 to 264 (± 3% R)	90 to 264 (± 3% R)
<b>Current (A)</b>	No	0 to 19.99 (± 5% R)	0 to 19.99 (± 5% R)	0 to 19.99 (± 5% R)	0 to 19.99 (± 5% R)	0 to 19.99 (± 5% R)
<b>Leakage Current (µA)</b>	0 to 1999 DC 25 Hz to 1 kHz (± 1% R) 1 kHz to 100 kHz (± 2.5% R) 100 kHz to 1 MHz (± 5% R)	0 to 1999 DC 25 Hz to 1 kHz (± 1% R) 1 kHz to 100 kHz (± 2.5% R) 100 kHz to 1 MHz (± 5% R)	0 to 1999 DC 25 Hz to 1 kHz (± 1% R) 1 kHz to 100 kHz (± 2.5% R) 100 kHz to 1 MHz (± 5% R)	0 to 1999 DC 25 Hz to 1 kHz (± 1% R) 1 kHz to 100 kHz (± 2.5% R) 100 kHz to 1 MHz (± 5% R)	0 to 1999 DC 25 Hz to 1 kHz (± 1% R) 1 kHz to 100 kHz (± 2.5% R) 100 kHz to 1 MHz (± 5% R)	0 to 1999 DC 25 Hz to 1 kHz (± 1% R) 1 kHz to 100 kHz (± 2.5% R) 100 kHz to 1 MHz (± 5% R)
<b>Resistance (Ω)</b>	0 to 1.99 (± 1% R) 2 to 19.99 (± 1% R) 10 mA	0 to 1.99 (± 1% R) 2 to 19.99 (± 1% R) 10 mA	0 to 1.99 (± 1% R) 2 to 19.99 (± 1% R) 10 mA	0 to 1.99 (± 1% R) 2 to 19.99 (± 1% R) 10 mA	0 to 1.99 (± 1% R) 2 to 19.99 (± 1% R) 10 mA	0 to 1.99 (± 1% R) 2 to 19.99 (± 1% R) 10 mA
<b>Patient Leads</b>	0	0	5	10	10	10
<b>MAP (Isolation)</b>	No	No	Yes	Yes	Yes	Yes
<b>Built-In ECG Simulator</b>	No	No	No	No	Yes	Yes
<b>AAMI &amp; IEC Loads</b>	AAMI Only	Yes	Yes	Yes	Yes	Yes
<b>Point-to-Point Test Points</b>	No	Yes	Yes	Yes	Yes	Yes
<b>Test Capability:</b>						
<b>Open Ground</b>	Yes	Yes	Yes	Yes	Yes	Yes
<b>Reverse Polarity</b>	Yes	Yes	Yes	Yes	Yes	Yes
<b>Open Neutral</b>	Yes	Yes	Yes	Yes	Yes	Yes
<b>Open Line</b>	Yes	Yes	Yes	Yes	Yes	Yes
<b>Size</b>	8.65 x 5.73 x 1.92 Inches	8.65 x 5.73 x 1.92 Inches	8.65 x 5.73 x 1.92 Inches	8.65 x 5.73 x 1.92 Inches	8.65 x 5.73 x 1.92 Inches	8.65 x 5.73 x 1.92 Inches
<b>Weight</b>	≤ 2.5 lbs (1.14 kg)	≤ 3.0 lbs (1.36 kg)	≤ 3.0 lbs (1.36 kg)	≤ 3.0 lbs (1.36 kg)	≤ 3.5 lbs (1.59 kg)	≤ 3.5 lbs (1.59 kg)
<b>Auto-Sequences</b>	No	No	No	No	No	Yes
<b>Bluetooth</b>	No	No	No	No	No	Yes



**BC Biomedical International Safety Analyzer Series**

The SA-2000-INTL Series is ideal for those needing a power cord that can be selected to meet their international power needs. One power cord is included with purchase. (BC20-20400 North America Power cord is included, if not specified. Power cord selection on page 134.)

SA-2000-INTL Base International Unit Model.....	<b>\$1042</b>
SA-2001-INTL Base Plus Point-to-Point and Voltage.....	<b>\$1389</b>
SA-2005-INTL 5 Test Lead Model.....	<b>\$1794</b>
SA-2010-INTL 10 Test Lead Model.....	<b>\$2119</b>
SA-2010S-INTL SA-2010-INTL w/built-in ECG Sim....	<b>\$2332</b>
A. SA-2600-INTL 10 Leads with Autosequences.....	<b>\$2447</b>
Additional & Replacement Power Cords (See page 134)	
RS-232-R Option.....	<b>\$168</b>

← **For more info on this series - Pages 63-68** →

**B. BC Biomedical CS-2000 Series**

The CS-2000 is a 1 amp current source series for testing to IEC 601 specs where a 1 amp source current is required.

CS-2000-E 220 V (European Version).....	<b>\$1268</b>
CS-2000-U 110 V (U.S. Version).....	<b>\$1117</b>

**Typical Power Cord Options Available for the SA-2000-INTL Series & SA-2500 With C-19 Connector**

C. BC20-20400 North America Hospital Grade.....	<b>\$86</b>
BC20-20401 Japan.....	<b>\$86</b>
D. BC20-20402 United Kingdom.....	<b>\$86</b>
BC20-20403 Schuko-Continental Europe with Schuko ground adapter.....	<b>\$106</b>
BC20-20409 India/South Africa.....	<b>\$86</b>
BC20-20410 Switzerland.....	<b>\$86</b>
E. BC20-20412 Italy.....	<b>\$86</b>
BC20-20416 Australia.....	<b>\$86</b>

**Safety Analyzer Cables**

F. BC20-20100 BC Biomedical Kelvin Cable (DNI Type)	
Will fit the following DNI/Fluke Biomedical models: 231, 232, 234, 235, 431, 432, u-Test2000 & all model medTesters...	<b>\$191</b>
G. BC20-20110 BC Biomedical Chassis (black) Cable (BC Biomedical/Dale Technology® Type).....	<b>\$131</b>
H. BC20-20111 BC Biomedical External (red) Cable (BC Biomedical/Dale Technology® Type).....	<b>\$131</b>
BC20-20115 BC Biomedical Kelvin Cable (BCB Type)...	<b>\$154</b>

**Scan** the code for all of our BC Group safety analyzer accessories and cables.



Digital Thermometers

Measurement range:  
 J-type: -346 °F to 2192 °F  
 K-type: -328 °F to 2501 °F

Fluke 50 Series

The Fluke 50 Series II thermometers feature fast response time with laboratory accuracy in a rugged hand-held tool. The Fluke 50 Series II contact thermometers have a relative time clock on MIN, MAX and AVG functions to provide a time reference for major events. The electronic offset function allows compensation of thermocouple errors to maximize the overall accuracy.

Prices include Calibration Certificate

**Fluke Series II 51-2** Single Input, with one bead thermocouple.....Call for Pricing

**A. Fluke Series II 52-2** Dual Input, with two bead thermocouples.....Call for Pricing

**B. Extech 445580 Humidity/Temperature "Pen"** .....\$191  
 Pocket convenience.

- Humidity: Range: 10 to 90%; Accuracy: ± 5%; Resolution: 1%
- Temp: Range: 32 °F to 122 °F; Accuracy: ± 1.5 °F; Resolution: 0.1 °F
- NIST Traceable Calibration Certificate Included

Temperature Adapters

Convert your DMM to a Temperature Meter.

**C. Fluke 80TK** DMM Temperature Adapter (w/Calibration Certificate).....Call for Pricing

**D. Fluke 80T-150UA** DMM Temperature Adapter (w/Calibration Certificate).....Call for Pricing

Thermocouple Probes for Fluke 50-series & Other "K" Type Temperature Meters

- E. Fluke 80PK-1** Bead thermocouple probe.....Call for Pricing
- F. Fluke 80PK-3A** Surface probe.....Call for Pricing
- G. Fluke 80PK-22** Immersion probe.....Call for Pricing
- H. Fluke 80PK-24** Air probe.....Call for Pricing
- I. Fluke 80PK-25** Piercing probe.....Call for Pricing
- J. Fluke 80PK-26** Extended bead probe.....Call for Pricing
- K. Fluke 80PK-27** Ruggedized surface probe..Call for Pricing

A



B



C



D



E

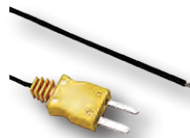

F



G



H



I



J



K



## BC Biomedical ULT-2000 TEE Tester Series

The ULT-2000 Series is designed to test the electrical safety of all types of diagnostic ultrasound transducers, totally independent of the ultrasound machine. Both models include PC Utility software and Battery Eliminator.

- ULT-2010 Base Model.....\$1395
- A. **ULT-2020** Base Plus Meter Mode and Datalogging...\$1661
- ULT-2020-7193 Leakage Tester for Intuitive Surgical's ION Catheter.....\$1744

### Optional Accessories For ULT Series:

- **ULT-PC-10** Dual Conductivity Probe (Short).....\$460
- B. **ULT-PC-15** Dual Conductivity Probe (Medium).....\$555
- **ULT-PC-20** Dual Conductivity Probe Set (Long & and Extra Long).....\$656
- **ULT-PC-25** For Gus System.....\$185
- **ULT-PC-30** Dual Conductivity Probe (Flexible).....\$460
- **ULT-AC-10** Fork Adapter.....\$441
- C. **ULT-SP-20** Splitter.....\$197
- **BC20-42350** GE/Sonosite ULT Test Kit (includes one each of the ULT-AC-10 and ULT-SP-20).....\$556
- D. **BC20-42200** Soak Tray (20").....\$432
- **BC20-42310** 5 Rolls of Printer Paper.....\$33
- **BC20-41361** RS-232 Communication Cable, USB(A)M to Mini DIN Male.....\$154
- **BC20-41337** RS-232 Communication Cable.....\$154
- **BC20-41339** USB to RS-232 Adapter.....\$154
- **BC20-42332** Print Kit .....\$1120  
(Includes 1 PRN-1130, BC20-42310, BC20-42325 and BC20-30107)

← For more info on this series - Pages 71-76 →

### Ultrasound Transducer Adapters (use with ULT-2000 Series)

- ULT-PA-10** Acuson/Siemens 8V5, 15L8W, V5M, 3V2C \$668
- ULT-PA-11** Sonosite Transducers, including TEE...\$668
- ULT-PA-12** Acuson/Siemens 260-PIN.....\$1413
- ULT-PA-13** Acuson/Siemens 156-PIN, V510B.....\$936
- ULT-PA-14** ATL/Philips C9-5 Curved Array.....\$1413
- E. **ULT-PA-16** GE LogicQ and GE P9603AU.....\$1413
- ULT-PA-17** Philips/ATL iE33 and iU22.....\$1413
- ULT-PA-18** Philips/HP 4500, Sonos 5500/7500.....\$912
- F. **ULT-PA-19** Philips CX50 Laptop Platform Only and Samsung Medison HM70A.....\$1473
- ULT-PA-20** Toshiba PVF Series, 2B701-753E.....\$936
- ULT-PA-21** Hitachi EUP-ES52M, EUP-Series Probes \$1413
- ULT-PA-22** Aloka SSD-620, SSD-650.....\$1413
- ULT-PA-23** ALL Transducers (Pencil).....\$782
- ULT-PA-24** Philips/ATL 256-pin, w/belled housing.....\$1413
- ULT-PA-25** GE LogiqBook Laptop platform transducers \$1473
- ULT-PA-26** Acuson/Toshiba.....\$2367
- ULT-PA-27** GE YMS/RT use with YMS/RT transducers....\$936
- ULT-PA-29** Zonare Medical Systems.....\$1043
- G. **ULT-PA-30** GE Vivid E9 and Samsung RS80A.....\$1580
- ULT-PA-32** Sonosite TEE X-Porte/T8-3.....\$1413

A



Also available in  
ULT-2020-7193  
Leakage Tester for  
Intuitive Surgical's  
ION Catheter

B



C



D



E



F



G



Is your facility compliant?

## IAC Standards and Guidelines for Adult Echocardiography Accreditation

2.2.3B The manufacturer's guidelines must be followed for the appropriate care and cleansing of the TEE transducer and adhere to the appropriate infectious disease standards to prevent the transmission of disease.

**Effective December 31, 2015, the structural and electrical integrity of the transducer must be checked between each use, using an ultrasound transducer leakage tester.** "Passed" or "Failed" must be documented in the routine TEE probe cleaning / maintenance log along with action taken if "failed."

## "How to" Video Series for the ULT-2000 series Ultrasound Leakage Tester

We strive to make the testing process simple and to help new customers use all ULT-2000 series testers. BC Group has put together a series of "How to" videos across a variety of topics. Scan the QR codes below each video to view and learn more about your Ultrasound Leakage Tester.

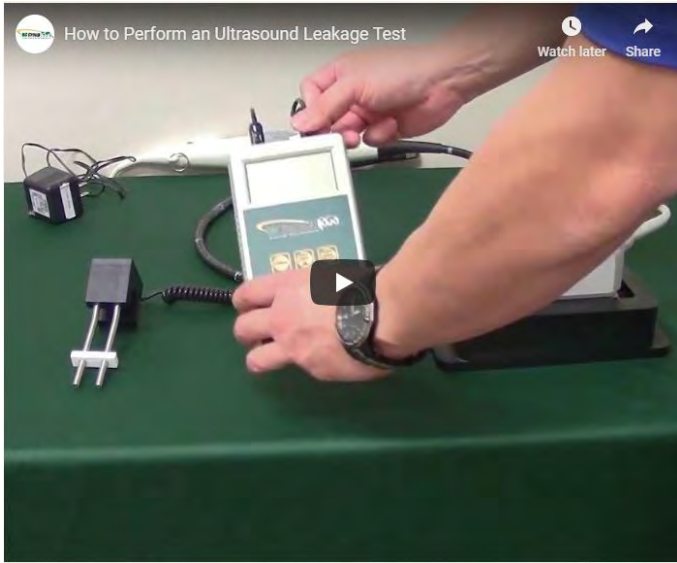

How to Perform an Ultrasound Leakage Test



How to Customize Your ULT



How to Perform an Ultrasound Leakage Test on GE Probes 6VT-D, 6Tc and 6Tc-RS



How to Perform an Ultrasound Leakage Test with a T8-3 SonoSite Transducer

**A. BC Biomedical USP-100SP Digital Ultrasound Wattmeter .....\$3311**

A compact, digital and affordable way to test both 1 & 3 MHz therapy ultrasounds. Great size for field service.

- 0.2 to 30.0 Watt Measure range,  $\pm$  3% accuracy
- 0.5 to 10 MHz Frequency response
- 3" Max transducer diameter
- Built-in transducer holder
- Degassed Water Testing medium
- Eight AA Batteries or 120V power
- Size / Weight: 8.5" H x 12" L x 8.75" W / 11 lbs
- RS-232 Port

A



**B. BC Biomedical USP-50SP Digital Ultrasound Wattmeter.....\$3594**

The USP-50SP, is designed to measure the ultrasound power output of diagnostic or therapeutic transducers up to 30 Watts. The water tank requires only one pint of de-gassed distilled water. If de-gassed water is not available, use distilled water. The principle of measurement is the radiant force method.

B



**C. BC Biomedical USP-30 Ultrasound Wattmeter .....\$2333**

Simple yet accurate. Uses a unique "balance beam" apparatus. Turn dial to balance indicator, take a dial reading and multiply by the calibration factor on the USP-30 to calculate Watts.

- Comes with a removable carrying lid
- 1 & 3 MHz Response
- Built-in transducer holder

C

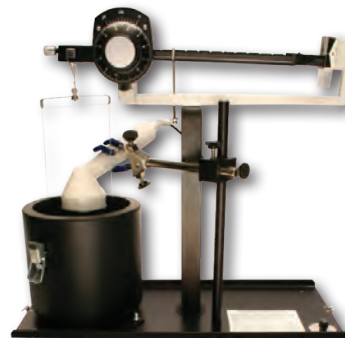

**D. UMA UMR-3D Digital Ultrasound Wattmeter .....\$3025**

From UMA -The people who developed the original soft membrane/water-coupled ultrasound wattmeter. Housed in a rugged metal case.

- 1 & 3 MHz Response
- Built-in transducer holder
- Sealed water well
- $\pm$  3% Accuracy
- Digital readout

D



← **For more info on this series - Pages 77-78** →

Educational Assistance Program

BC Group has designed a program to assist schools with Biomedical Training Courses to obtain the latest BC Biomedical Test Equipment at a discounted price, when the products are used for instructional purposes. For more information, contact our main Sales office via email [sales@bcgroupintl.com](mailto:sales@bcgroupintl.com) or phone 800-242-8428.



H



I



J

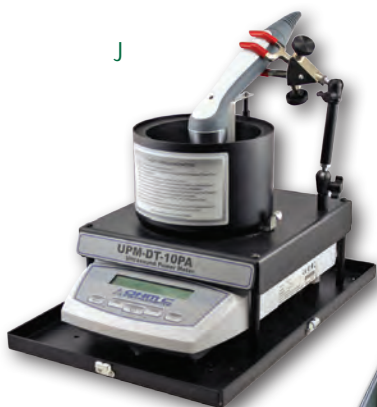

K



L



M

**H. UPM-DT-1000PA.....\$7065**

Electronic ULTRASOUND POWER METER. Resolution 1 mW (Highest resolution). Fastest Response (Under 3 seconds). Range 0 to 30 Watts at a frequency of 0.5 to 10 MHz. Digital display, RS-232 interface. Carrying case. The high resolution and fast response makes the UPM-DT-1000PA ideal for R&D and manufacturing.

It features a high contrast alphanumeric LCD display. Membrane "touch buttons" enable quick setup, selection of units for the power reading (grams or watts "custom mode") and printer output control.

**I. UPM-DT-1PA.....\$6414**

Electronic ULTRASOUND POWER METER. Resolution 2 mW or 1.5 mW in grams mode. Range 0 to 30 Watts at a frequency of 0.5 to 10 MHz. Digital display, RS-232 interface, carrying case.

It features a high contrast alphanumeric display. Membrane "touch buttons" enable quick setup, selection of units for the power reading (grams or watts "custom mode") and printer output control.

**J. UPM-DT-10PA.....\$4328**

Electronic ULTRASOUND POWER METER. Resolution 20 mW or 15 mW in grams mode. Range 0 to 30 Watts at a frequency of 0.5 to 10 MHz. Digital display, RS-232 interface, carrying case.

It features a high contrast alphanumeric display. Membrane "touch buttons" enable quick setup, selection of units for the power reading (grams or watts "custom mode") and printer output control.

**K. UPM-DT-100SP.....\$3311**

Electronic ULTRASOUND POWER METER. Resolution 200 mW or 150 mW in grams mode. Range 0 to 30 Watts at a frequency of 0.5 to 10 MHz. Digital display, RS-232 interface. Carrying case.

It features a high contrast alphanumeric LCD display. Membrane "touch buttons" enable quick setup, selection of units for the power reading (grams or watts "custom mode") and printer output control.

**L. UPM-DT-50SP.....\$3594**

Electronic ULTRASOUND POWER METER. Resolution 50 mW. Range 0 to 30 Watts at a frequency of 0.5 to 10 MHz. Digital display. Optional USB or RS-232 interface. Includes molded polyethylene case.

It has a smaller footprint and it's highly portable. Making for quick easy set up.

**M. UPM-30.....\$2333**

Mechanical ULTRASOUND POWER METER. Resolution 150 mW. Range 0 to 30 Watts at a frequency of 0.5 to 10 MHz. Carrying case. Mechanical base manual zero.

It consists of a precision mechanical balance, which measures from 0.01 to 10.00 grams, a conical target suspended on a hanger, a water tank, a transducer support rod with clamp and a carrying case.

← For more info on this series - Pages 95-96 →

## Selection Guide For Ohmic's Ultrasound Power Meters



	UPM-DT-1000PA	UPM-DT-1PA	UPM-DT-10PA	UPM-DT-100SP	UPM-DT-50SP	UPM-30
Power Range	0- 30 Watts	0- 30 Watts	0- 30 Watts	0- 30 Watts	0- 30 Watts	0- 30 Watts
Transducer Range	0.5-10MHz	0.5-10MHz	0.5-10MHz	0.5-10MHz	0.5-10MHz	0.5-10MHz
Resolution	1 mW	2 mW	20 mW	200 mW	50 mW	±150mW
Display Sensitivity	0.001 Watt	0.002 Watt	0.02 Watt	0.2 Watt	0.05 Watt	N/A
Accuracy	± 3% @10 Watts, 25°C	± 3% @10 Watts, 25°C	± 3% @10 Watts, 25°C	± 3% @10 Watts, 25°C	± 3% @10 Watts, 25°C	± 5%
Zeroing Method	Push to Zero	Push to Zero	Push to Zero	Push to Zero	Push to Zero	Vernier Dial
Stabilization	<3.0 Second Integration	≤3.0 Second Integration	≤3.0 Second Integration	≤3.0 Second Integration	≤3.0 Second Integration	N/A
Cone Target Size	3.25" diameter x 1.125" high	3.25" diameter x 1.125" high	3.25" diameter x 1.125" high	3.25" diameter x 1.125" high	3.25" diameter x 1.125" high	3.25" diameter x 1.125" high
Test Media	Degassed Water	Degassed Water	Degassed Water	Degassed Water	Degassed Water	Degassed Water
Max Transducer Size	4 1/2" Diameter	4 1/2" Diameter	4 1/2" Diameter	4 1/2" Diameter	4" Diameter	4 1/2" Diameter
Computer Interface	RS-232, 600-19200 Baud *USB Optional	RS-232, 600-19200 Baud *USB Optional	RS-232, 600-19200 Baud *USB Optional	RS-232, 600-19200 Baud *USB Optional	RS-232, 600-19200 Baud *USB Optional	Does not apply
Power	120 VAC/12 VAC 500 mA adapter 6 Ft. cord	120 VAC/12 VAC 500 mA adapter 6 Ft. cord	120 VAC/12 VAC 500 mA adapter 6 Ft. cord	120 VAC/12 VAC 500 mA adapter 6 Ft. cord or 4 AA's	120 VAC/12 VAC 500 mA adapter 6 Ft. cord or 4 AA's	Not required
EMI Rating	CE, CSA, UL	CE, CSA, UL	CE, CSA, UL	CE, CSA, UL	CE, ICES	N/A
Electrical Safety	CE, CSA	CE, CSA	CE, CSA	CE, CSA	CE, ICES	N/A
Size	11"H x 15" L x 10"W	11"H x 15" L x 10"W	11"H x 15" L x 10"W	8"H x 12" L x 8.75"W	7"H x 10.5" L x 8.5"W (In case) * 6"H x 16.75" L x 12"W (assembled)	19"H x 17" L x 7"W
Weight	16 Lbs Net	16 Lbs Net	16 Lbs Net	11 Lbs Net	8.5 Lbs * 9.75 Lbs Net	18 Lbs Net
Carrying Case	Black Anodized Aluminum	Black Anodized Aluminum	Black Anodized Aluminum	Black Anodized Aluminum	Molded polyethylene	Black Anodized Aluminum

# NEW SA-2600

FULLY AUTOMATED SAFETY ANALYZER WITH 10 PATIENT LEADS & ECG SIMULATOR

The SA-2600, the latest in the Electrical Safety Analyzer Family is **NOW AVAILABLE FOR PURCHASE!**

The SA-2600 has fully customizable autosequences allowing for a full run-through of testing with limited user interaction.



Scan QR Code for information on our SA-2600



US Plug Shown

- ▶ True RMS Readings
- ▶ Wireless with myBC Mobile
- ▶ 4.3 inch Color Touchscreen
- ▶ External Leakage Current
- ▶ Custom & Fixed Autosequences
- ▶ 200 mA Earth/Ground Resistance

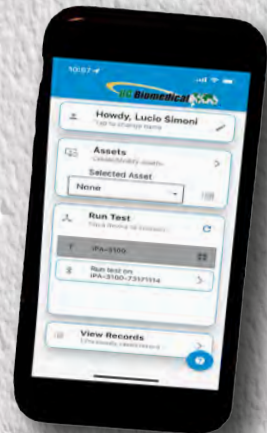



3081 Elm Point Industrial Dr.  
St. Charles, MO 63301

Mail Room:  
If Addressee not available  
please deliver to:  
- Biomedical Engineering  
- Clinical Engineering  
- Service Manager

## 2023 - 2024 CATALOG



The IPA-3100 is a highly accurate, easy-to-use, compact, single channel analyzer.

It incorporates an intuitive interface with a full color 4.3" touch screen.

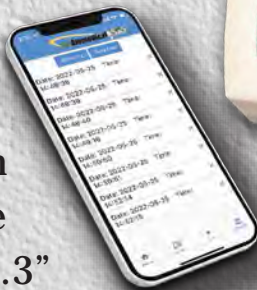

- Smooth Dual Syringe System
- High Accuracy
- Auto Start
- Rechargeable Battery
- 0.1 mL to 1000 mL/Hr
- Configurable Pressure Unit (PSI, mmHg, mBar, kPa)



IPA-3100

# IPA-3100

COMPACT BLUETOOTH®  
INFUSION PUMP ANALYZER

myBC mobile  
Compatible!



iOS



Android OS